

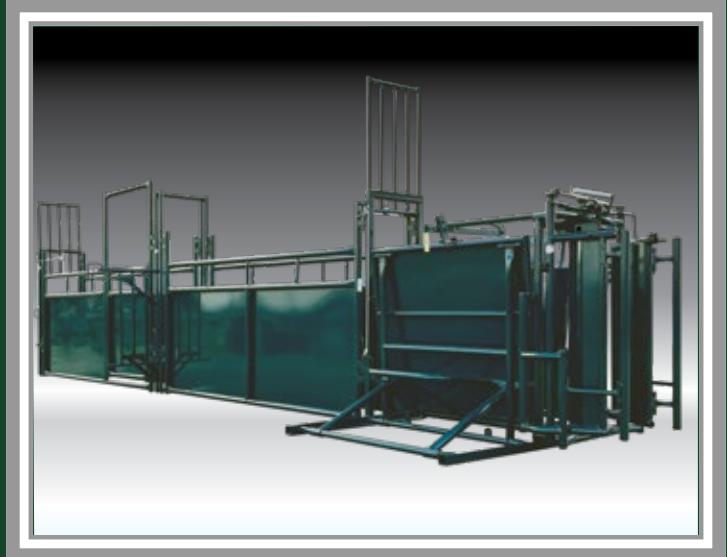

CATTLE ♦ BISON ♦ EQUINE ♦ RODEO ♦ PARKS

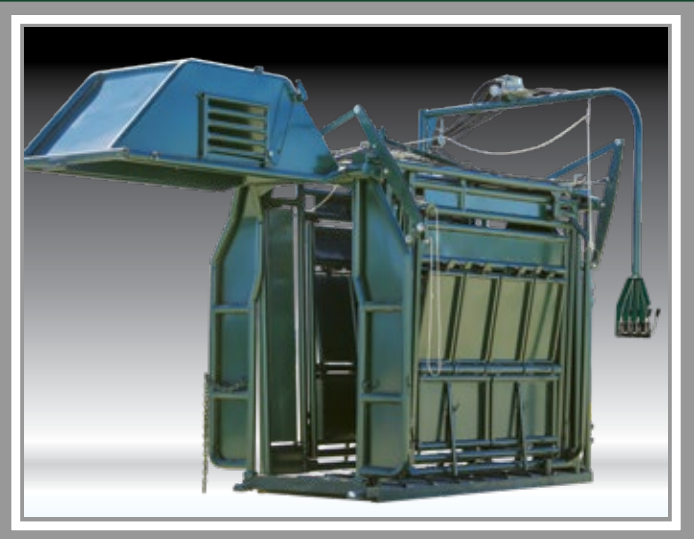

CALVING ♦ CUSTOM SYSTEMS ♦ WELLFENCE



2026 PRODUCT GUIDE

HYDRAULIC OPERATED HEAD HOLDER - NEW FOR 2026

#1534 - 100 lbs.

ENGINEERED FOR SAFER, SMOOTHER PROCESSING

The new Hydraulic Operated Head Holder for 2026 enhances the control and efficiency of Hi-Hog's Hydraulic PA Squeeze Chute. Designed to connect directly to the spare hydraulic port on the main directional control valve, this attachment allows the operator to position and secure the animal's head using the existing chute controls.

EXPANDED HYDRAULIC CAPABILITY — BUILT IN

By integrating directly into the chute's hydraulic system, the Head Holder delivers smooth, controlled movement without additional pumps or external controls. The result is improved precision, safer handling, and reduced operator strain.

ENGINEERED TO FIT - DESIGNED TO UPGRADE

This model bolts directly to the right-hand headgate stanchion and includes weld-on brackets for earlier pre-2024 models.



DESIGN & PERFORMANCE FEATURES

#1534 - Hydraulic Operated Head Holder

Seamless Hydraulic Integration

- Connects directly to open port on the main directional control valve
- Operated using existing chute control levers
- No additional hydraulic power unit required

Secure & Controlled Positioning

- Provides precise head control during treatment or examination
- Maintains steady restraint without manual effort
- Improves operator control and livestock safety

Clean Installation

- Bolts directly to the right-hand headgate stanchion
- Weld-on brackets included for pre-2024 models
- Engineered specifically for the Hydraulic PA Squeeze platform

Built for Working Ranch Conditions

- Heavy-duty construction
- Designed for repeated use in high-pressure handling situations
- Maintains Hi-Hog's reputation for durability and performance



TRAILER AND LOADING CHUTE

Multi-Use Transport | 04
Loading Chute | 05

4

BISON EQUIPMENT

Hydraulic Squeeze | 06
Manual Squeeze | 07
Control Alley | 08
Facility Design | 09

6

CATTLE SQUEEZE CHUTES

Hydraulic Cattle Chute | 10
Pump Options | 10
PA Manual Cattle Chute | 12
Self-Catch Headgate | 13

10

MANUAL HEAD HOLDERS

Hydraulic Squeeze
Manual Head Holder | 14
PA Manual Squeeze
Head Holder | 15

14

CATTLE HANDLING EQUIPMENT

Manual Headgate - Longhorns | 16
Calving Headgate - Sternum Bars - Extensions - Parts | 16
Palpation Options - Sorting Alley Sections | 20
Cattle Crowding Tubs | 21
Sheeted Panels - Walkways - Alley Spreaders | 22

16

CATTLE HANDLING SYSTEMS

Combination Alleys - Adjustable U-Alleys | 24
S-Alley Handling Systems | 29
Double Alley Handling Systems | 31
Ultimate Handling System | 32

24

CALVING EQUIPMENT

Maternity Tub | 33
Calving / Trimming Chute | 34
Calving Enclosure | 35
Calf Alley - Tipping Table | 36

33

Paddock Slab / Bull Tipping Table

Paddock Slab Stabilization Tiles | 38
Bull Tipping Table | 38
Gates and Panels Overview | 39

38

PANELS & GATES

Panels - Panels with Access Gates | 40
Gates - Gate Closure Options | 42
U-Frames - Frame & Gates - Spreaders | 44
Cattle Guards - Utility Fencing | 46

39

LIVESTOCK FEEDERS

Nifty Roll Out Feed Dispensors | 47
Fence Line Feeders - Feeder Panels | 48
Round Bale Feeders | 49

47

EQUINE EQUIPMENT

Box Stalls - Foaling Panels - Feed Tubs | 50
Standing Tie Stalls - Feed Mangers | 52
Portable Event Stalls | 52
Round Pens - Portable Corrals | 54

50

RODEO SYSTEMS

Rough Stock / Bucking Chutes | 55
Timed Event Chutes - Sorting Arrow | 56
Rodeo System Design | 19

55

PARK EQUIPMENT

Bleacher Frames | 58
Picnic Table Frames / Fire Boxes | 58
Park Bench Frames | 59
UTV Cattle Guard | 59

58

MULTI - USE TRANSPORT TRAILER

***Special Order**

Trailer #1574, 758 Lbs

Panel Rack #5538, 419 Lbs

Towing Capacity - 5000 Lbs

Length 15' 10-3/8"

Width 7' 6-7/8"



The Multi-Use Transport Trailer is capable of transporting any of Hi-Hog's Bison or Cattle Squeeze Chutes. With the upgraded spindles, axles and tires the towing capacity has been increased to 5,000 lbs.

Hydraulic Cattle Squeeze - Loaded
Length - 17' 5-3/16"
Height - 8' 10-9/16"



The manual winch connects to the frame and linkage system with 4 lifting chains, attaches to the lifting brackets that are welded on all 2024, and later Bison and Cattle Squeeze Chutes. The design allows the Trailer to be backed into place while still being connected to the towing vehicle. Once the Squeeze Chute is raised, it rests on two crossbars, which are removed during the loading / unloading process. The Squeeze Chute is then secured in place using 2 ratchet straps.



#1574 Multi-Use Trailer
+ #5538 Panel Rack = 1177 Lbs



The Multi-Use Transport Trailer is for more than just Squeeze Chutes. It can be used along with the #5538 Panel Rack to transport your S-Alley Handling System to wherever you wish to set up your handling system. With the optional Panel Rack you have the ability to move Gates, Panels, Stalls and Systems, freely, around your Ranch.

ADJUSTABLE LIVESTOCK LOADING CHUTE

Stationary Loading Chute, Item #76



Portable Loading Chute, Item #75



Optional panel hangers, item #77, can be mounted to the loading chute to transport livestock panels

Note: The transport kit should be removed, and the loading chute secured in place, before loading or unloading livestock. ITEM #74



The overhead bow frame is shipped to our dealers in the lowered position (below Left). When you receive your loading chute, loosen the two set screws and raise the overhead bow frame to your desired height (below right).

The Loading Chute is lined with 48" high Hot Roll on the sides.

The Ramp is 1/8" Checker Plate with 1.25" square tubing, welded cleats on 9" centre. The Ramp Surface is finished with a high grip textured polyester powder coat finish.

4-Adjustable Stabilizer Legs are included to level the Loading Chute on any Surface.

The Bottom Ramp pivots down and rests on the rear stabilizer plates. The Top Ramp pivots up and latches at the height of the livestock trailer.

The Bottom Ramp adjusts easily with the assistance of an internal spring.

The optional Transport Kit (item #74) is available for ranchers that want to use the Loading Chute at multiple sites.

The Portable Loading Chute #75 comes with a 2,000 lb Screw Jack to assist with levelling the Loading Chute.

The rear verticals are equipped with Hi-Hog's standard Panel Connectors.

The axle capacity of the transport kit is 3,196 lbs.

Use the QR Code to visit Hi-Hog Website Loading Chute Page



Ramp height easily adjusts to provide loading heights from 16" to 48", using the adjustment lever.

The heavy duty, Checker Plate Loading Ramp quickly adjusts for secure loading from stock trailers to cattle liners.

Universal Loading Chute		
#	Description	Weight (lbs)
74	Transport Kit	196
75	Portable Loading Chute	1594
76	Stationary Loading Chute	1398
77	Panel Hanger	12
Length with transport kit		16'-7"
Length without transport kit		12'-6"
Inside width of chute		32"
Shipping height		8'-5"
Shipping width at base		50"
Shipping width at chute body		36.5"

HYDRAULIC BISON SQUEEZE CHUTE

#2367 with Electric Hydraulic Pump - 3762 lbs.

#2369 with Gas Hydraulic Pump - 3782 lbs

The parallel axis squeeze action draws both slightly tapered sides in, and forward, at the same time, to support and control the Bison in a balanced central position.

The smooth interior reduces bruising and prevents the Bison from climbing the walls.

Bison have little respect for open cages and will make every effort to simply run through them.

Hi-Hog's Crash Cage is fully sheeted except for a small front window and two side windows. The windows provide enough light to encourage forward movement but not so much that your bison want to run through it.



Hydraulic Pump options (see page 11)
> Electric Pump (Item #1559)
> Gasoline Pump (Item #1562)



HYDRAULIC BISON SQUEEZE CHUTE FEATURES

- Full width opening, both front and back
- Quick, safe access to all parts of your animal - both sides
- Hydraulic locks on all circuits allow soft catch but positive lock
- Can do everything from both sides
- 3-way sorting; front and two sides
- Lift-up crash cage allows safe access to both sides of head
- Controls mounted on pivot to allow operation from best visibility and away from animal's sight

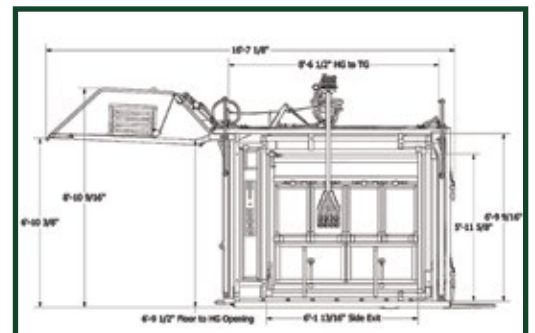

MANUAL BISON SQUEEZE CHUTE

#2360 - 3108 lbs.

To make the chute less of a threat, both the tail gate and head gate open to the full width of the squeeze chute. This provides your bison with unobstructed flow into and out of the bison chute.

The heavy checker plate floor includes sturdy 1.25" square traction bars on thirteen inch centers to ensure your stock feel confident and secure standing on the floor.

The Head Cage is balanced with a counterweight for effortless manual operation. Like the hydraulic model, the head cage swings up so that the handler or vet have clear, safe, access to your bison's head.



Hi-Hog's Bison Squeezes come standard with three exit options; straight through the head gate, or out either the left or right side exit gates.



Each of the side exit gates come with four drop down panels for easy access to the body, two lift-up panels for access to the feet, and one full height shoulder panel for access to the shoulder. All panel latches come with quick locks to safely secure the latches against accidental opening.

The # 2360 Manual Bison Squeeze Chute is built on the same frame as the Hydraulic Chute. The parallel squeeze, headgate, tail gate, and crash gate are easily operated with manual controls. The crash gate includes a balanced counterweight for remarkably safe and easy operation.



#2360 Manual Bison Squeeze - 3108 lbs.
#1574 Multi-Use Trailer - 578 lbs
With a towing capacity of 5,000 lbs., you can move either the Hydraulic Bison Squeeze or Manual Bison Squeeze, pasture to pasture, with ease.
(see page 4)

BISON CONTROL ALLEY

#	BISON ALLEY EQUIPMENT	WEIGHT (LBS)
2367*	Bison Hydraulic Squeeze Chute / Electric Pump	3762
2369*	Bison Hydraulic Squeeze Chute / Gas Pump	3782
2360*	Bison Manual Squeeze Chute	3108
2195*	Bison 3-Way Connector Post - 7' high	14
2330*	Bison Control Alley - Left Spreader with door	340
2295*	Bison Control Alley - Gate in frame	432
2305*	Bison Control Alley - Roof Panel	127
2315*	Bison Control Alley - Adjustable Side Panel	273
2320*	Bison Control Alley - Right Spreader with door	340
2130*	Bison 10'w x 7'h Sheeted Panel	350
2190*	Bison 5' wide Rolling Door	351
2196*	Bison 4-Way Connector Post - 7' high	14.5
2340*	Bison Control Alley - Interior Spreader	399
2285*	Scale Platform - Call with make before ordering	435

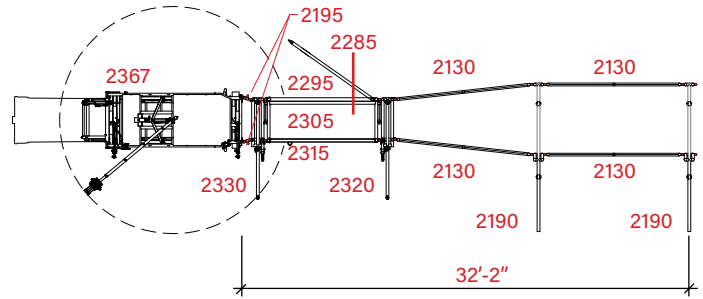

* Bison Handling Equipment is built several times throughout the year. All equipment may not be on hand at the time of ordering.

Info on Hi-Hog's bison panels and gates can be found in the panel and gate section of this guide. See pages 42 - 45. Available in lengths from 4' to 16' and both 7-Rail and Sheeted designs.

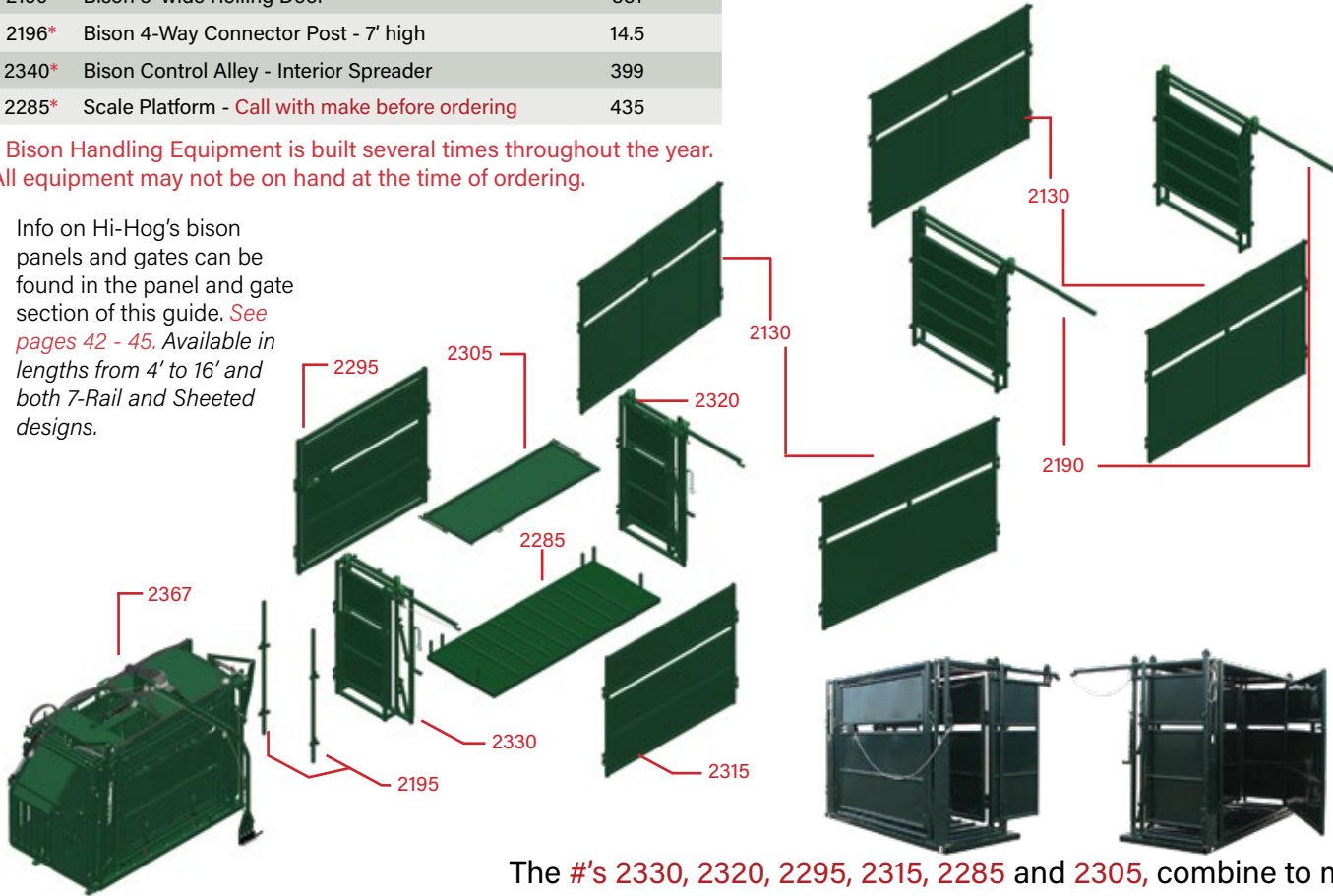

The #'s 2330, 2320, 2295, 2315, 2285 and 2305, combine to make a reversible Control Tub. A Bison Handling Safety Essential.

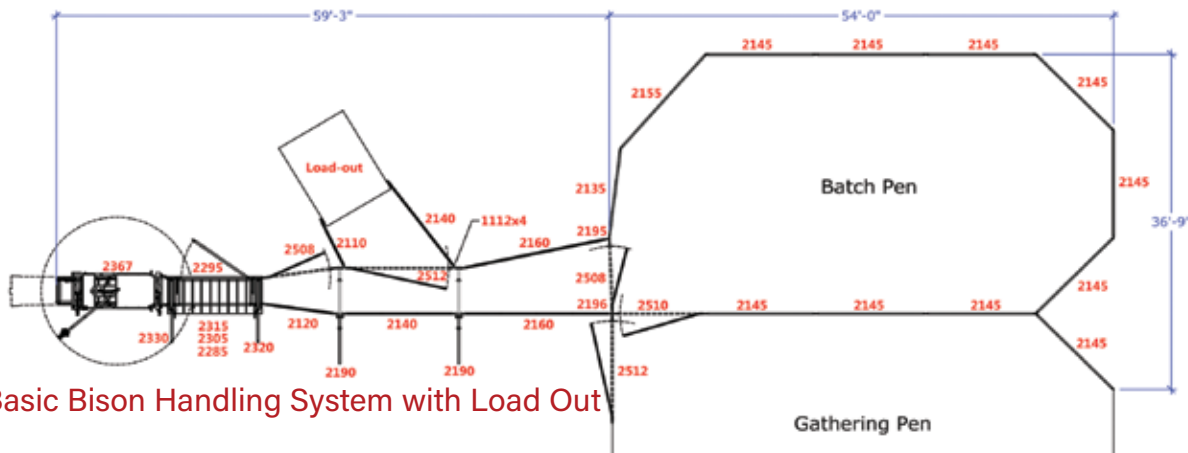

Hi-Hog Basic Bison Handling System with Load Out

BISON HANDLING FACILITY DESIGN

Hi-Hog's design and sales team have decades of experience working with bison, and bison producers.

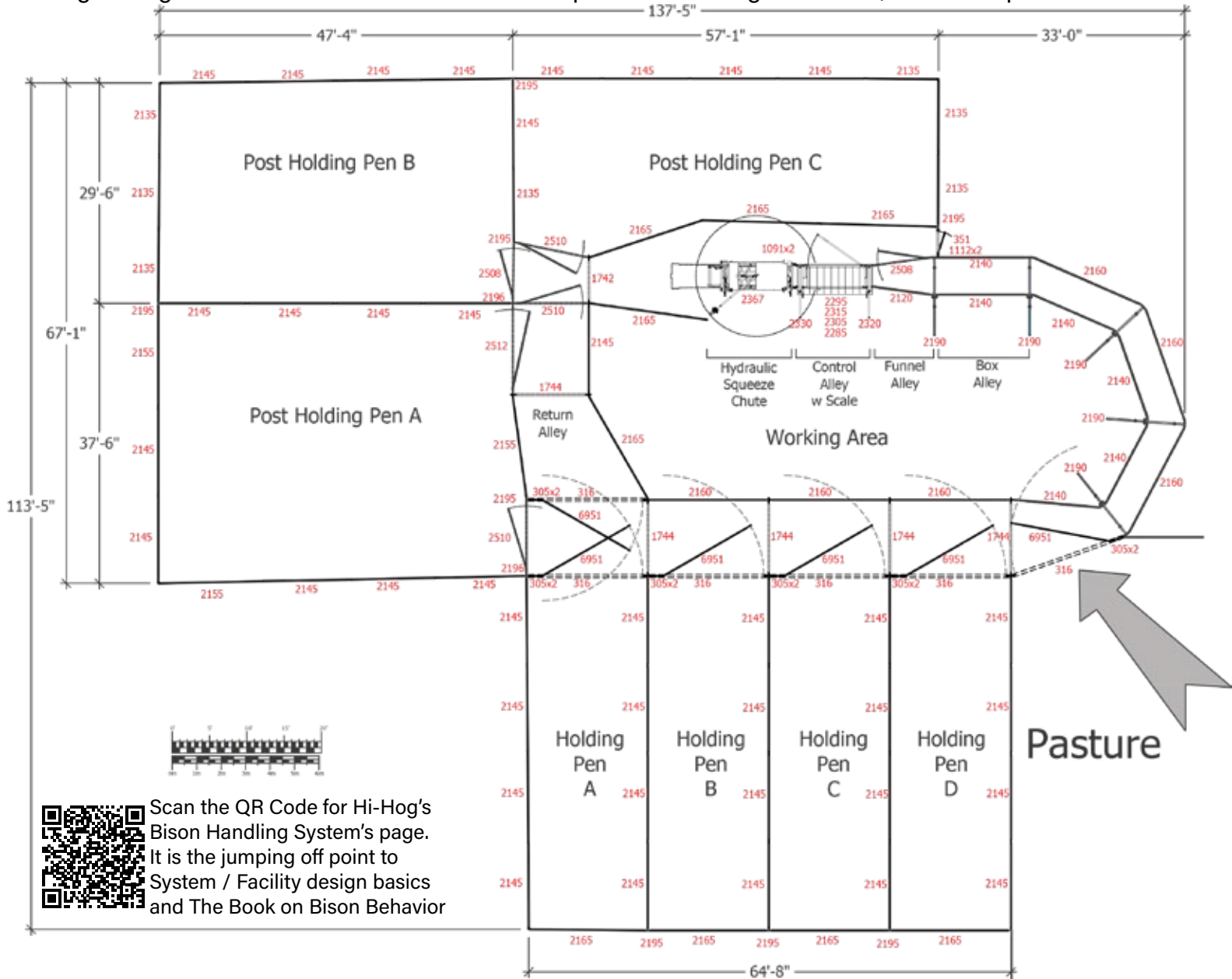

Scan the QR Code for Hi-Hog's Bison Handling System's page. It is the jumping off point to System / Facility design basics and The Book on Bison Behavior



HYDRAULIC CATTLE SQUEEZE CHUTE



HEADGATE VIEW

Hi-Hog's Hydraulic Cattle Squeeze Chute is Built for Speed and Engineered for Safety – Minimize stress on your livestock and reduce labor time with fast, responsive hydraulic controls that optimize your workflow.

FEATURES - UNMATCHED ANIMAL ACCESS

- Pivot controls let you work the chute and the animal, with 340 degree rotation
- 4 hydraulic controls; headgate, tailgate, squeeze sides, plus a spare
- Hydraulic locks on each circuit
- Factory set pressures (1200 psi)
- Parallel headgate yolk ensures equal pressure on the animal from the top of the headgate to the bottom
- Heavy duty sheeted headgate and tailgate open fully (32" opening)
- Floor door track designed for easy clean-out
- Headgate mounted with contact absorption springs
- Includes removable neck extender
- 2026 Models come with Base Brackets for the # 1574 Multi-Use Trailer Attached.
- 2026 Models come with welded on, mounting brackets for the #1535-LH/RH Head Holder
- Primary latches come with locks to prevent accidental opening
- Chute comes standard with 2 side exits
- Sloping sides support your animal while allowing animal to maintain a balanced footing
- Both exits can be opened from the working side of the chute
- Hoof and body access panels open flat against the chute body
- Latches for the body access panels include locks and guards
- The bottom interior of the chute is enclosed with 12ga Hot Roll
- Sheeted components are caulked for quiet, low stress operation
- Each chute includes 26 grease zerks to ensure reliable smooth operation
- Primary hinge collars are pre-greased with arctic grade grease for extreme weather use
- Premium quality Nylon control ropes
- Double Coated, durable polyester powder coat finish
- Rubber latch sleeves reduce noise and vibration for low stress handling
- Your choice of Electric Powered or Gas Powered Hydraulic Power Pack

HYDRAULIC CATTLE SQUEEZE CHUTE

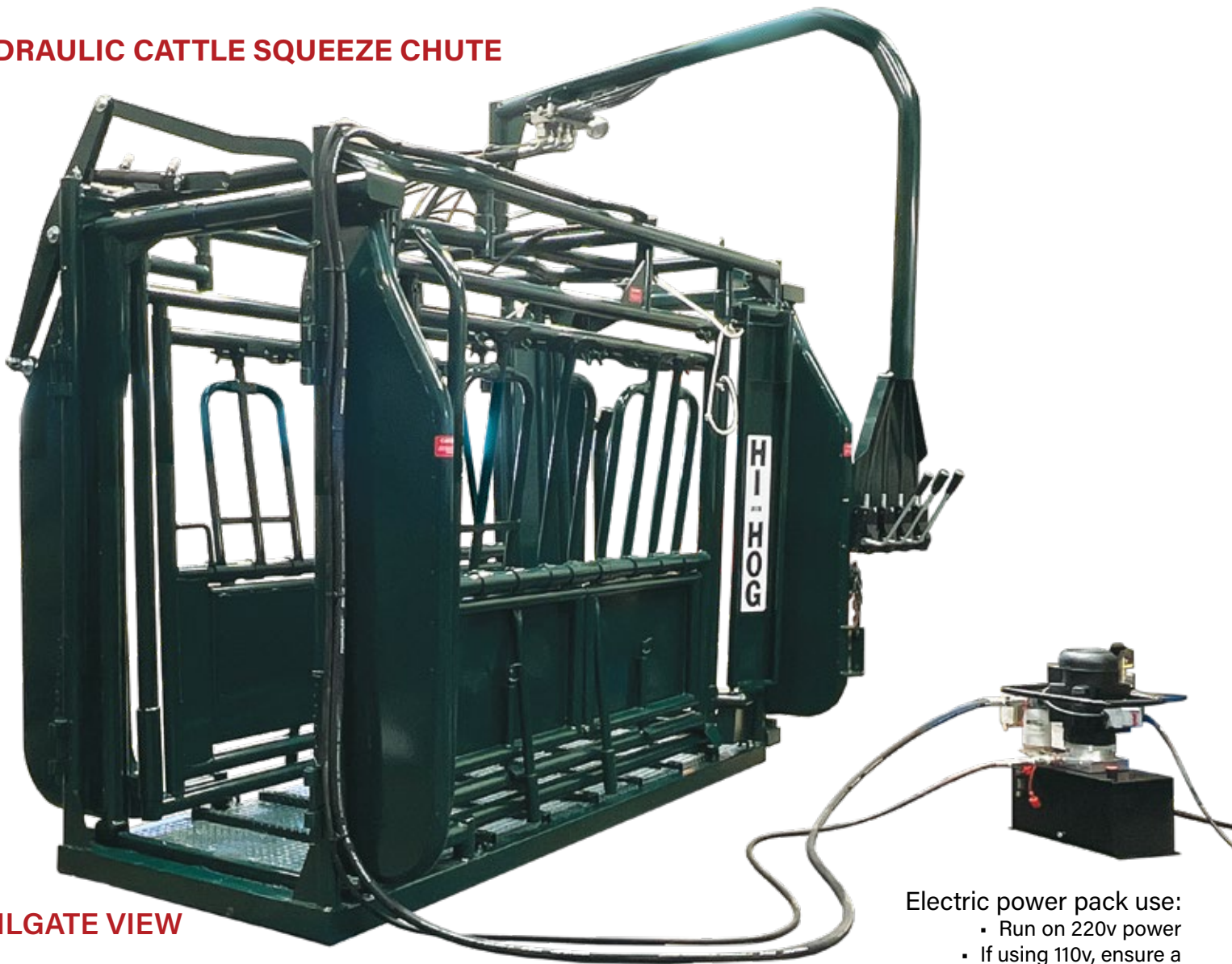

TAILGATE VIEW

More Work Done with Less Effort - The Hydraulic Squeeze comes with an extra valve, for attaching a #1534 Hydraulic Head Holder, Rolling Door or a #55 - Calf Tipping Table to your System.

Hydraulic Parallel Axis Squeeze Chute	
#1556 / electric power pack	2,331 lbs
#1566 / gas power pack	2,351 lbs
#1563 / no power pack	2,204 lbs
Outside Length	118-9/16"
Inside Length	99"
Outside Height	96-1/4"
Inside Clearance	72-1/2"
Base Width	40"
Inside Width - Wide	32"
Inside Width - Narrow	12-1/2"
Weight (chute only)	2,204 lbs

Electric power pack use:

- Run on 220v power
- If using 110v, ensure a 20-amp breaker minimum.
- Do not use an extension cord

**Note: Unless otherwise requested, all power packs come wired for 220v power from the factory.*

ELECTRIC OR GAS HYDRAULIC PUMP OPTIONS

The 2 horsepower Electric Pump is set to pump 1.5 gallons/minute at 1000 psi. The electric pump can be run on either 110 V or, **for best performance use 220 V.**

The 5.5 horsepower Gas Pump offers 15.2 gallons/minute at low pressure and 3.3 gallons/minute at high pressure.



Electric Hydraulic Pump
Item #1559, Weight 127 lbs (full tank)



Honda Gas Hydraulic Pump,
Item #1562, Weight 147 lbs (full tank)

MANUAL PARALLEL AXIS SQUEEZE CHUTE - #1550

Safe for Livestock and Rancher

- The inside of the side panels are sheeted smooth at the bottom
- The sheeted panels are caulked to absorb vibration and reduce noise
- Gaps are minimized to reduce the potential for livestock injury
- All access gates come with an additional slide latch for added security
- Simple, refined design ensures smooth, dependable operation
- Heavy-duty checker plate steel floor with large 1.25" square traction bars

Premium Quality Components

Hi-Hog uses premium accessory components built to last the life of your Squeeze Chute:

- 3/8" double braided nylon ropes
- Custom tooled Tivar sheaves
- Hi-Vis, high-grip handle covers
- Heavy duty 1/4" head restraint chain
- Extra heavy duty timing chain
- Grease fittings on all hinge collars

Hi-Hog's parallel axis squeeze chute combines outstanding design, materials and construction to create a safe, rugged, and easy to operate chute with outstanding access and control.

Manual Parallel Axis Squeeze Chute

Item #	1550	1551	1571
Outside Length	108"	120"	108"
Outside Height	85"	85"	85"
Outside Width	58"	58"	105"
Base Width	40"	40"	40"
Inside Length	96"	96"	96"
Inside Height	72.5"	72.5"	72.5"
Inside Width - Wide	32"	32"	32"
Inside Width - Narrow	12.5"	12.5"	12.5"
Weight (Lbs.)	1,702	1,875	1,840

#1536 LH/RH Head Holder page 15

Squeeze options see page 16-17

2024-26 Parallel Axis Squeeze Chutes come with Lifting Brackets attached



Unmatched Animal Access

- Dual side exit gates provide access from either side of the chute
- Both side exits can be operated from the working side for added safety and convenience
- All access points lock securely in the closed position
- Body access gates open fully and lay flat for unobstructed working space
- Heavy-duty latching system allows quick, secure operation

Each Side Exit Includes:

- Four drop-down body access gates
- Two lift-up lower access gates
- One removable shoulder access panel



Balanced Animal Control

- Parallel squeeze action keeps livestock centered and balanced in the chute
- The sides slope to provide animal support without forcing the animal to narrow their footing
- Two offset locking ratchets provide smooth, continuous squeeze width adjustments from 32" down to 12"
- The rear side drop down panel includes slots for a back-up bar
- Rubber latch sleeves reduce noise and vibration for low stress handling

Designed Around the Rancher

- Squeeze controls can be easily moved from one side of the chute to the other for left-hand or right-hand operation
- Sort three ways; left side exit, right side exit, or straight through the headgate
- The rear tailgate, with built-in counterweight, locks automatically in both the raised and lowered position
- The tailgate includes a long, responsive control rope so the rancher can activate the tailgate while working outside of the animal's flight zone.

SELF CATCHING HEADGATE - #100 - STANDARD ON ALL #1550 SQUEEZE CHUTES

To minimize bruising, the headgate is mounted to the squeeze body with shock-absorbing spring bolts

Extra heavy-duty timing chain for smooth dependable operation

The headgate is operated with one simple handle. Push the handle forward (the direction out of the squeeze chute), and the headgate swings into the squeeze chute. Push the handle in towards the squeeze and the headgate will open out.

The headgate will swing in or out to the full width of the squeeze chute. This minimizes the risk of hip-lock

Quick adjust plungers on the top and bottom of the headgate, allow you to set the headgate width between 5" and 11". No tools required

Grease fittings on all hinge collars



The stanchions include two safety guards just above the bottle neck. These guards protect the locking plates from being accidentally released by a horn

Auto-catch position is quickly set with the simple limiter chain (shown in red for clarity). Simply push the headgate in to the width that you want and draw the chain in behind the headgate doors and latch the chain in the slotted lock bracket

Headgate handle is available separately (page 16)

The stanchion narrows above 48" to minimize stock from swinging their head up. This bottleneck design remains parallel below this height

The lower chain is available to help secure the head. The chain, with pigtail chain retainers, can be easily set and released

The headgate is sheeted to protect livestock and focus their attention on the exit

Parallel Axis Self-Catch Headgate
Item #100, 295 Lbs

NECK EXTENDER - #105 - OPTIONAL ON #1550

Neck Extender - Item #105, 173 Lbs
**Special Order*



Hi-Hog's Neck Extender is linked directly to the self-catch headgate, allowing the Neck Extender to be activated by the animal's shoulders at the same time the animal contacts the self-catch headgate.

This feature allows the animal to catch itself without a handler at the headgate.

Note: When setting the width of the Neck Extender, ensure that it is set to the same settings as the headgate.

HEAD SWEEP - #1561 - OPTIONAL ON #1563

Head Sweep - Item #1561, 95 Lbs
**Special Order*



The Hydraulic Head Sweep provides an alternative to the neck extender on Hi-Hog's hydraulic squeeze chute.

Hi-Hog's hydraulic chute includes a spare valve so hook up is simple.

The Head Sweep arm is long enough to prevent stock from ducking under the sweep.

Note: this unit needs to be welded onto the headgate and cannot be used with the Neck Extender in place.

HYDRAULIC SQUEEZE CHUTE / MANUAL HEAD HOLDER

Manual Head Holder For Hydraulic Squeeze Chute - Item #1535-LH or #1535-RH, 108 Lbs

Shown is the #1563 Hydraulic Squeeze Chute Body and Attached #1535-RH Head Holder RH = (Right Hand Installation, meaning on animal's Right Side) #1535 also fits on the #107 Manual Headgate. Our 2024-2026 Runs of #1563 Hydraulic Squeeze Chute Bodies include Mounting Brackets welded on both sides of the Headgate, for the #1535 Head Holder.

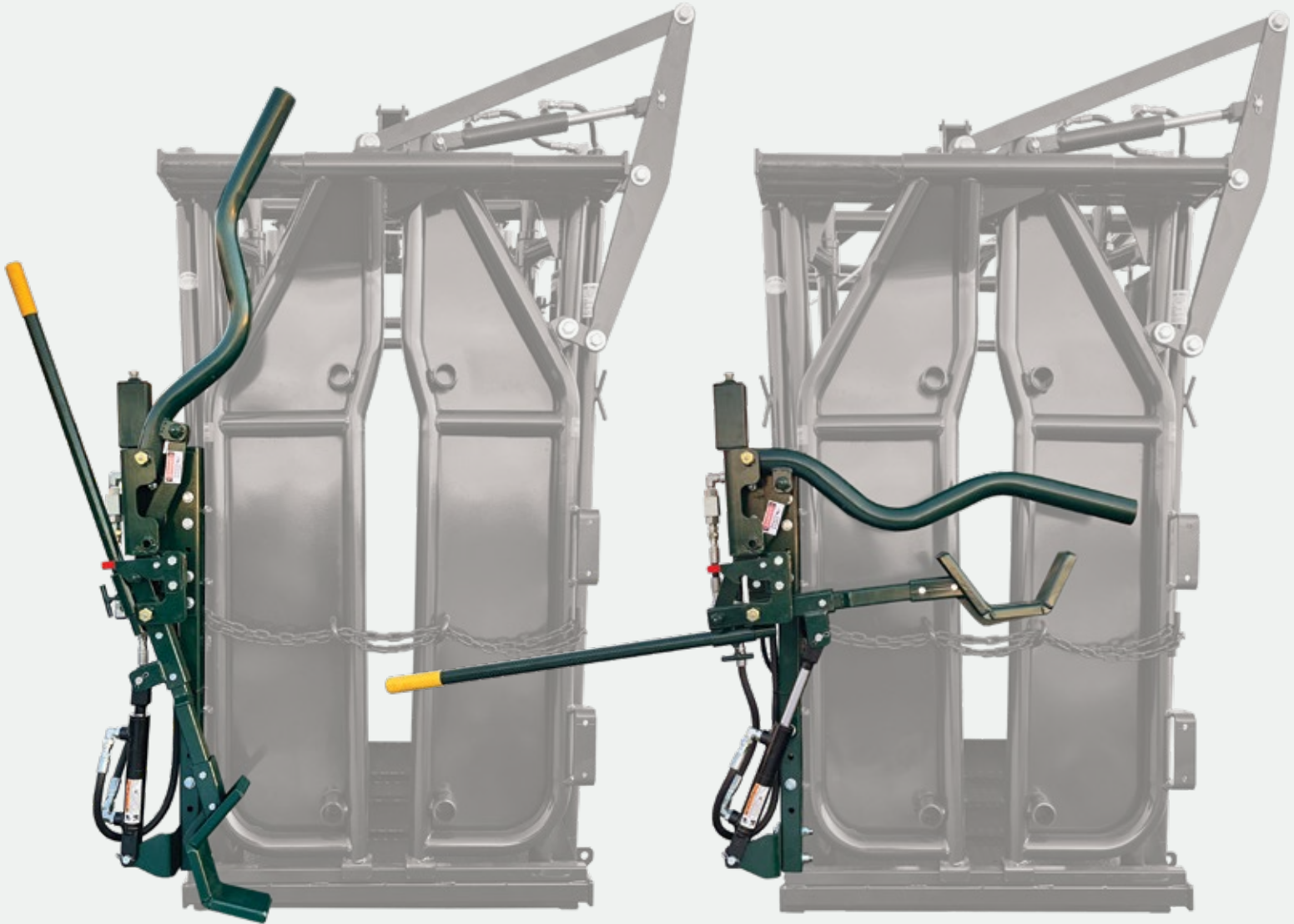

Manual Head Holder For Hydraulic Squeeze Chute and #107 Manual (Scissor) Headgate - Item #1535-RH is Shown, 108 Lbs
The #1535 and #1536 Head Holders are manually operated with a self contained Hydraulic Lock Reservoir.



- 3 Height Settings
- One Size fits all
- No spring or friction lock points to wear out and slip during use
- Grease fittings on all primary pivot points
- Can lock in the closed position for optimal handler safety
- If retrofitting a #1556 Hydraulic Squeeze Chute, Brackets must be welded in place for the Head Holder to bolt onto. (Included)
- Not for use with #1561

MANUAL PARALLEL AXIS SQUEEZE CHUTE HEAD HOLDER

Manual Head Holder For Manual P. A. Squeeze - Item #1536-RH and #1536-LH, 122 Lbs

Shown is the #1550 with Attached #1536-RH
(Right Hand side of the animal)

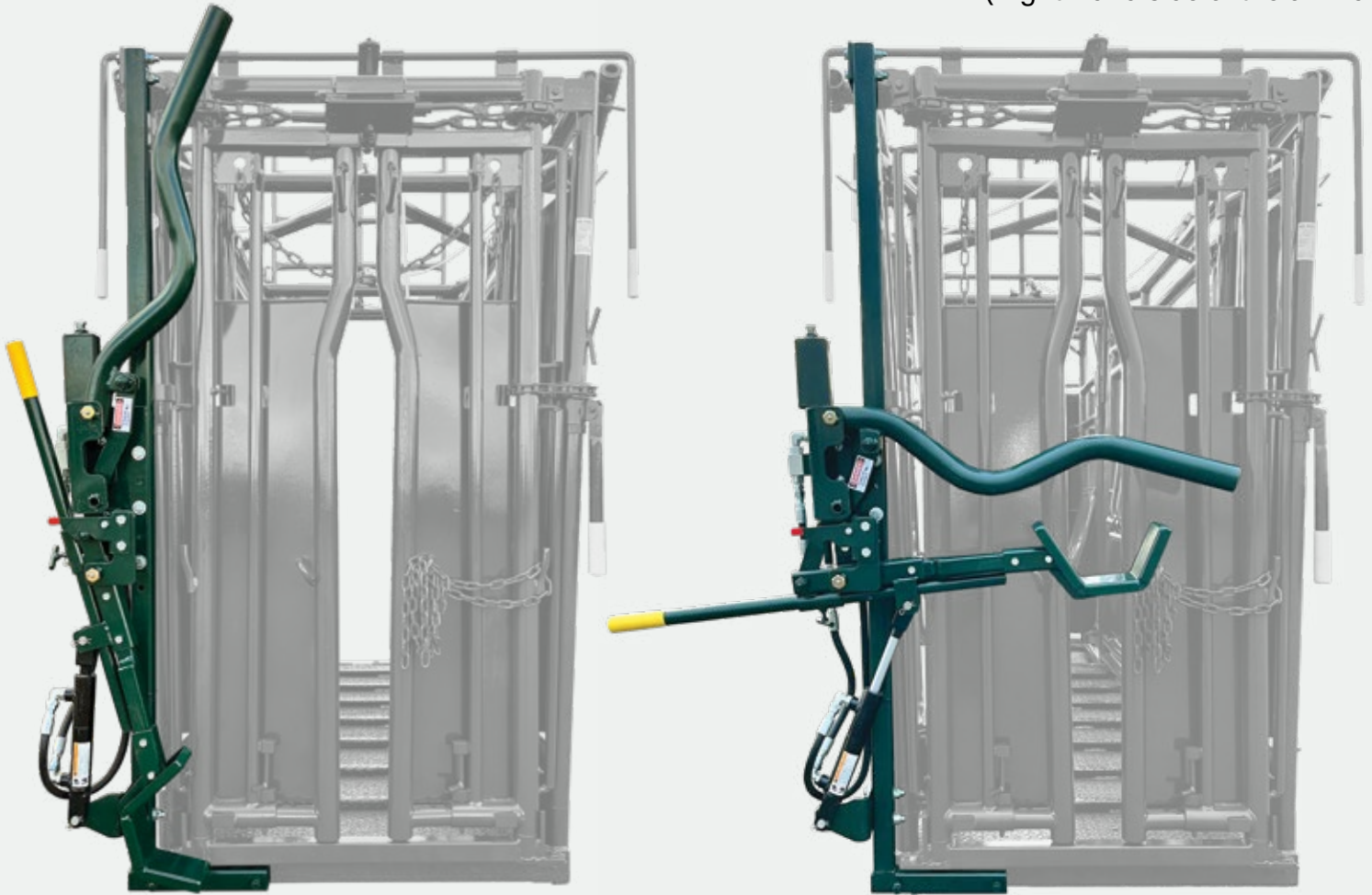

SAFETY AND SECURITY FOR THE ANIMAL AND THE OPERATOR

With Hi-Hog's Head Holder, you can safely and comfortably secure the animal's head, ensuring minimal movement during procedures. A simple Up / Down Handle will release the fluid in the reservoir and re-apply the lock instantly, without the need to fully open the head holder.

The Red Handle locks the Head Holder in the open position when it is not needed.

- Provides safe, reliable and quiet head control when needed
- Fully reversible for left or right hand operation
- Bolts onto all current or earlier models of Hi-Hog's Parallel Axis Squeeze Chute
- The use of a #1554 Sternum Bar is recommended, but not necessary
- The Secure Hydraulic Lock has its own reservoir and does not require a pump
- Curved head yoke and cradle provide superior head control without reducing animal access
- Does not interfere with the shoulder access panel

STERNUM BAR

Item #1554, 28 Lbs

A Sternum Bar encourages livestock to remain on their feet while standing in the cattle squeeze chute. Hi-Hog's Sternum Bar pins into two floor mounted brackets secured to the floor of the chute. The floor brackets can be mounted in two positions, allowing the Sternum Bar to be quickly Installed or Removed.



A Sternum Bar is recommended with all Head Holders

MANUAL HEADGATE - Longhorn

Item #107, 434 Lbs

*Special Order



#107 MANUAL HEADGATE -comes with 4 Brackets attached for easy mounting of #1535-LH/RH Head Holder [page 15](#)

CALVING HEADGATE

Item #110, 239 Lbs

- Hi-Hog's Self-Catch Calving Headgate lets the animal catch itself so you can use your time to work the animal.
- Set with the Limiter Chain and release with the Headgate Handle.
- The Overhead Latch works independently forwards and back.
- The Self-Catch Calving Headgate fits on Hi-Hog's Calving Enclosure or Calving / Trimming chute.
- Quick adjust plungers on the top and bottom of the head gate make it possible to adjust the calving head gate opening on the fly.
- The three available stanchion openings are 5", 7.75" and 10.5" in width.



Item #110 - Self Catching Calving Headgate comes standard on Hi-Hog's Calving Pen / Enclosure [P. 34/35](#)

STERNUM BAR

Item #1554, 28 Lbs

A Sternum Bar encourages livestock to remain on their feet while standing in the cattle squeeze chute. Hi-Hog's Sternum Bar pins into two floor mounted brackets secured to the floor of the chute. The floor brackets can be mounted in two positions, allowing the Sternum Bar to be quickly Installed or Removed.

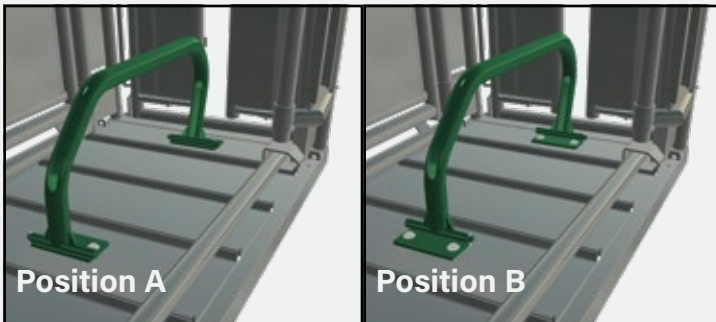

20" SQUEEZE EXTENSION (PA)

Item #1537-20 , 195 LBS *special order

The 20" Squeeze Extension pins directly to the back of Hi-Hog's manual Parallel Axis Squeeze Chute.

Like the PA Squeeze Chute, the Extension includes a solid floor, sheeted sides, and back-up-bar slots.



RETRO-FIT HEADGATE HANDLE (PA)

Item #1555, 8 Lbs



You can add a retro-fit headgate handle (#1555) to any Hi-Hog PA chute built after zzzzzzzzz2003. Installation of this handle will require some cutting and welding. This handle comes with all new PA squeeze chutes. This handle is required when adding a neck extender on your chute.

Call for installation instructions.

RATCHET BARS (PA)

Item #1549, 6 Lbs



TAILGATE COUNTERWEIGHT (PA)

Item #1547, 9 Lbs



SIDE EXIT BLOCKING BAR

Item #1565, 25 LBS *special order

The 64" Squeeze Side Exit Blocking Bar can be used when full access to the side of the animal is required.

Two set screws at the top allow you to slide the bar along the inside frame of the squeeze chute and lock it into place.



SQUEEZE PARTS

HEADGATE HANDLE (PA)

Item #101, 4 Lbs



TIMING CHAIN SET - OLD STYLE (PA)

Item #103, 5 Lbs



TAILGATE - For #1550 PA Squeeze Chute

Item #1546, 24 Lbs



Hi-Hog's standard Tailgate is installed on all Manual PA Squeeze Chutes. This is the same Tailgate that is used in the assembly of our #37 Alley Spreader with lift up gate.

SIDE SHEAVE ASSEMBLY (PA)

Item #1552, 1.5 Lbs

The sheave can be ordered on its own as item #1547-S (hardware not included)



SQUEEZE BODY HANDLE (PA)

Item #1544, 7.5 Lbs



The replacement handle can be quickly and easily installed.



Scan the QR Code to view Hi-Hog's Website for Squeeze Chute Options

CUSTOM FACILITY DESIGN SERVICES

Hi-Hog's extensive experience designing facilities for handling large animal breeds has attracted facility owners from around the world to partner with Hi-Hog. These projects often require some combination of stock and custom-made solutions as well as collaboration with a variety of stakeholders including architects and engineers. Visit hi-hog.com for samples

Livestock Auction Facilities

Auction facilities are complex systems that require rigorous planning to ensure they work safely, efficiently and profitably from load-in to load-out.

Large Animal Veterinary Facilities

Every design brief is different, but that's what we love about these projects. How can we help you reach the goals of your veterinary practice?

Veterinary Education Facilities

We're honored to have long standing relationships with some of the leading veterinary training facilities. Our veterinarians play an important role in the health of our industry and we take great pride in helping to educate our future veterinarians.

Specialty Equine Facilities

From Therapeutic Riding Centers, Horse Boarding Facilities, Equestrian Campgrounds, Horse Rescue and Rehabilitation Centers, Riding Clubs,

Equestrian Communities, Horse Shows and Exhibitions, to Elite Horse Jumping Facilities, Hi-Hog continues to help all of these organizations meet their unique requirements.

Zoo & Wildlife Facilities

We have consulted and supplied feeding and handling equipment for a variety of large animals at zoos and wildlife parks around the world. Tap into our experience in designing the systems and making the equipment you need.

Rodeo Arenas

From private riding arenas to professional rodeo arenas, our design team will help you meet your goals. Large scale rodeo facilities require careful planning to ensure the resulting facilities work for all participants; livestock, riders, stockman, field crew, operations, and spectators.

Grazing Reserves/Community Pastures

Shared Corrals require superior sorting solutions to ensure simple, and efficient cattle processing and loading.

Custom Product Design & Production Manufacturing

If metal manufacturing is not your principle skill, we encourage you to consider the benefits of partnering with our highly skilled team of designers and makers.



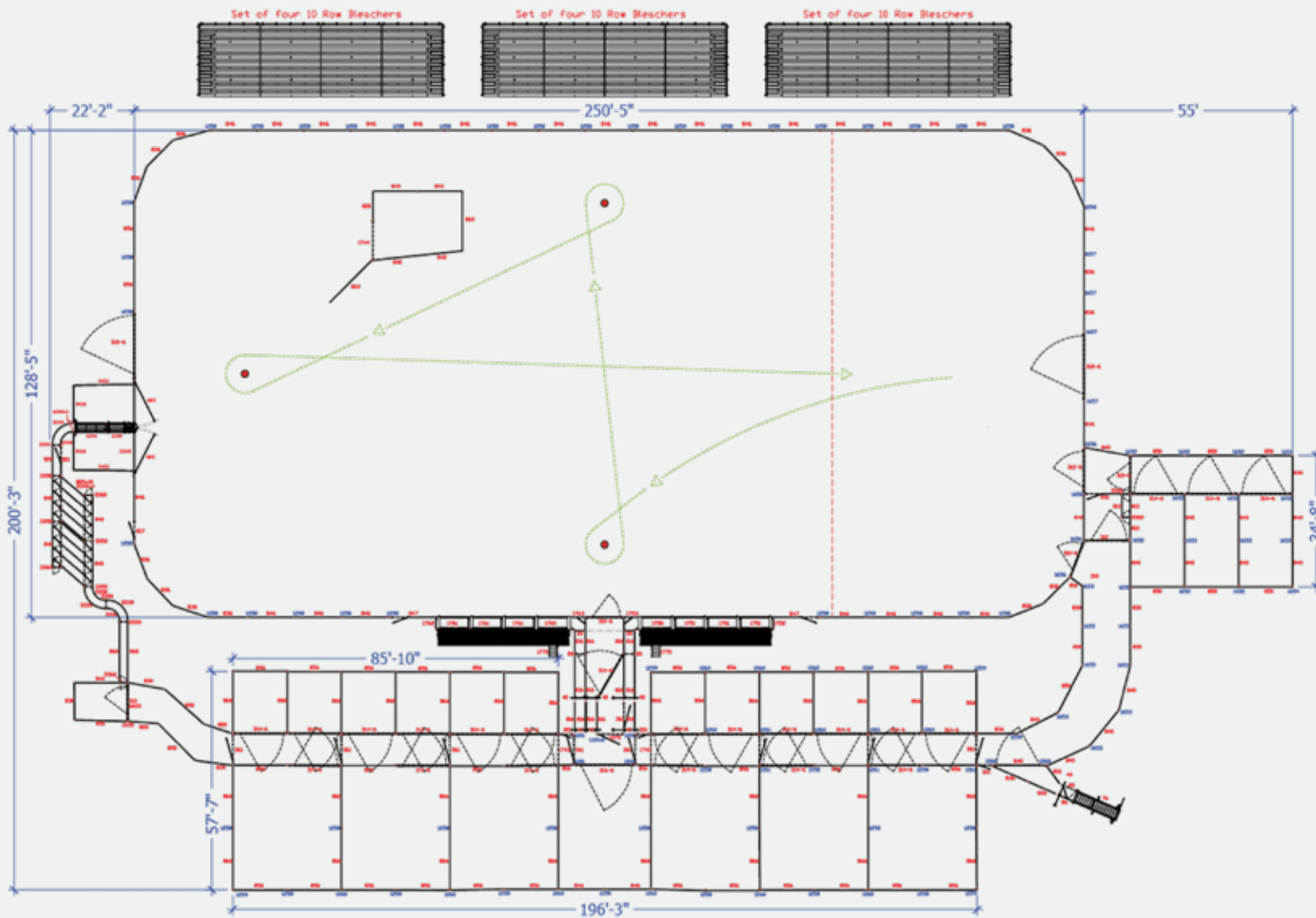

MULTIPLE EVENT RODEO ARENAS

Rodeo arenas can vary widely both in size and in program requirements. The more events you wish to host the more complex the arena design is likely to be. Arenas designed for a variety of events usually require more complex penning solutions to efficiently control both the variety of stock, as well as the potential for multiple stock suppliers.

The success of a public rodeo arena often depends on how safely and efficiently you can hold and move your livestock. This is particularly true if your rodeo is an event where spectators have paid to see a show. Your spectators don't want to be kept waiting while you struggle to get the correct animal into the correct chute. [page 56](#)

ROUGH STOCK RODEO EVENTS

Hi-Hog's rough stock arena's feature their outstanding rodeo bucking chutes which can be ordered with left or right-hand exits. The modular design allows for flexible design as well as for easy facility expansion. Behind Hi-Hog's bucking chutes you will find their rough stock stripping chute as well as an array of penning solutions to meet your rodeos stock needs. Hi-Hog also offers a wide range of heavy duty panel and gate options. [page 39](#)

Whether you're installing a permanent or a portable holding corral Hi-Hog's experienced design team can help you develop a plan that meets your requirements. Hi-Hog's designers will also provide you with an accurate itemized quote.

RODEO and EVENT SEATING

Hi-Hog's Bleacher Frame packages are 16' long engineered bleacher frames, available in 5-Row and 10-Row models. Hi-Hog's bleacher frame kits are ideal for Ag Societies, Parks, & Arena's. Call us at 1-800-661-7002 to start the design process. The bleacher frame package includes steel frame and steel frame fasteners. [page 58](#)

NOTE: Wood and wood fasteners are not included with this package.

PALPATION AND SORTING OPTIONS

PALPATION CAGES

Hi-Hog offers both a fixed width, and an adjustable width Palpation Cage. Both palpation cages include access gates on either side of the alley. These gates come with adjustable plunger latches for quick and secure latching. The gates can be swung in and latched securely across the entrance of the Palpation Cage to block cattle flow and provide safe vet access to the rear of the squeeze chute. The Palpation Cage frames have a width of 32", an inside length of 33.5", and a height of 80". The entry gates are 66" high.

For processing calves, the bottom of the adjustable Palpation Cage side doors swing in and latch securely. When not in use, the lower panels can be latched open to the full alley width.

- Fixed Palpation Cage - #80, 234 lbs
- Adjustable Palpation Cage - #1560, 292 lbs



#80 Fixed Palpation #1560 Adjustable Palpation

P.A.S.S. GATE & P.A.S.S. PANEL

The Palpation And Sorting Section (P.A.S.S.) panel and P.A.S.S. gate can be added to your working alley to create an adjustable 4' long alley section that can be used for handler and vet access, sorting animals out of the alley, or diverting stock into another alley.

Hang the P.A.S.S. panel or P.A.S.S. gate on Hi-Hog's adjustable alley spreaders to create a fully adjustable alley section that can be adjusted from 32" down to 18" in width.

These items use the same common connectors as our system panels. You can combine them to add access and isolation points throughout your Hi-Hog handling system.

- P.A.S.S. Gate - #85, 130 lbs
- P.A.S.S. Panel - #86, 96 lbs

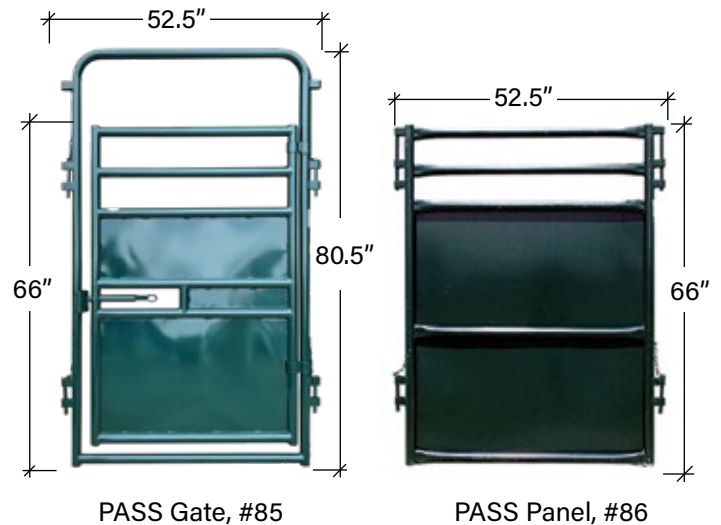

SORTING ALLEY SECTION

Hi-Hog offers a variety of 7' sheeted system panels that can be used in the same manner as the P.A.S.S. panel and P.A.S.S. gate. Hang these items on our adjustable alley spreaders to create a 7' long alley section you can sort or divert animals through.

- #1370, 7' Sheeted panel with access gate and sort gate 80" high frame, 66" high gates, 233 lbs
- #1375, 7' Sheeted panel with large gate 80" high frame, 66" high gate, 209 lbs
- #1380, 7' Sheeted panel with small sort gate 80" high frame, 66" high gate, 209 lbs
- #250, 7' Sheeted panel - 66" high panel, 147 lbs
- #251, 7' Sheeted panel - 60" high panel, 133 lbs

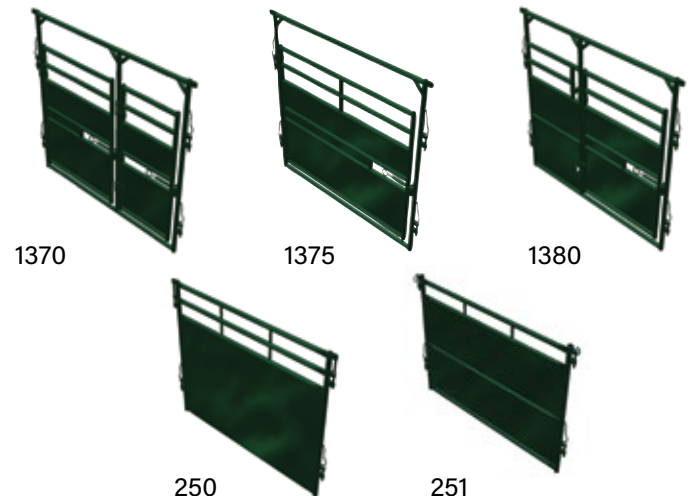

CATTLE CROWDING TUBS

We have over 75 crowding tub, bud box, and flight bulb designs. The following are the most common.

Funnel Tub: half circle tub with funnel extension						
	Size of Tub*			Item Description	#	Lbs
	1/6	1/3	1/2			
Pcs Required	1	2	3	10' Curved Tub Section	230	209
	1	2	3	Overhead Tub Spreader	270	46
	1	1	1	Tub Pivot Gate	280	435
	1	1	1	7' Straight Panel with Double Gates	1370	233
	1	1	1	S-Alley B-Section - 66" high	1340	216

Tub size based on portion of a full circle. A 3-section tub will make 1/2 of a circle

The funnel section can be created with either the 7' load-out panel (#1370 shown), or a straight panel with a single gate (#1380), or simply a 7' straight panel (#250)

Half circle tub with 250 extension						
	Size of Tub*			Item Description	#	Lbs
	1/6	1/3	1/2			
Pcs Required	1	2	3	10' Curved Tub Section	230	209
	1	2	3	Overhead Tub Spreader	270	46
	1	1	1	Tub Pivot Gate	280	435
	1	1	1	7' Straight Panel	250	147

Tub size based on portion of a full circle. A 3-section tub will make 1/2 of a circle

Half circle tub with 240 Extension						
	Size of Tub*			Item Description	#	Lbs
	1/6	1/3	1/2			
Pcs Required	1	2	3	10' Curved Tub Section	230	209
	1	2	3	Overhead Tub Spreader	270	46
	1	1	1	Tub Pivot Gate	280	435
	1	1	1	9'-3" Straight Alley Panel	240	195

Tub size based on portion of a full circle. A 3-section tub will make 1/2 of a circle

Return Tub - Tub based on a Bud Box			
Pcs	Item Description	#	Lbs
4	10' Curved Tub Section	230	209
4	Overhead Tub Spreader	270	46
1	Tub Pivot Gate	280	435
1	6' High U-Frame	310-6	209
1	5' High x 8' Long Heavy Duty Gate with plunger latch	6651	105

1/3 circle tub with reverse flow			
Pcs	Item Description	#	Lbs
2	10' Curved Tub Section	230	209
2	Overhead Tub Spreader	270	46
1	Tub Pivot Gate	280	435
1	9'-3" Straight Alley Panel	240	195

NOTE: A #235 walkway can be hung on the outside of a curved tub panel. #230

NOTE: The Overhead Tub Spreader and Pivot Gate come with a ground stake. To prevent your livestock from re-aligning your tub components we recommend you stake your tub to the ground. The ground stakes can also be ordered separately. 3/4" Ground stake - #271 - 3Lbs

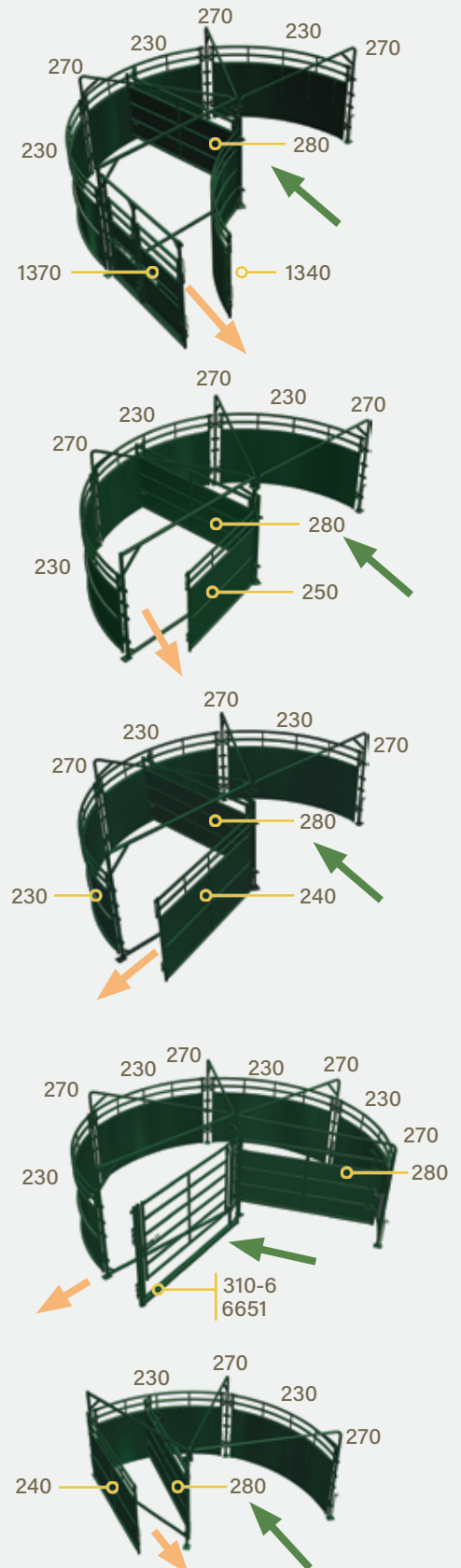

Further explanation, samples and installation instructions can be found at www.hi-hog.com

Non-Adjustable 32" Alley Parts

66" high Panel

#86
4'6" PASS
Panel
96 lbs



#1440*
10' Curved
Section
195 lbs



#1380
7' Alley
Sort Gate
214 lbs



#240
9' 3" Alley
Panel
195 lbs



#1402*
7'6" U-Alley
A1 Section
151 lbs



#251
7' Alley
Panel
133 lbs



#241
9' 3" Alley
Panel
177 lbs



60" high Panel

Adjustable U-Alley Parts

#1401!
9' U-Alley
Section
168 lbs

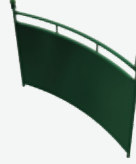

Note: Item #1401 will only connect to the outside of the U-Alley spreaders, or U-to-S Alley spreaders.

These panels hang on wheels rather than the standard connectors found on all of the remaining Hi-Hog system panels.

#1402*
7'6" U-Alley
A1 Section
151 lbs



#250
7' Sheeted
Alley Panel
147 lbs



#251
7' Alley
Panel
133 lbs



Plan View

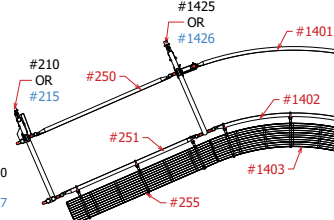
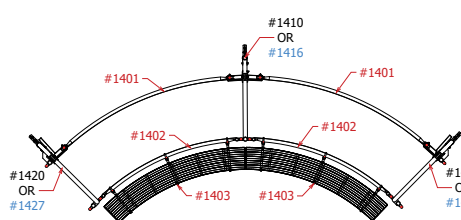
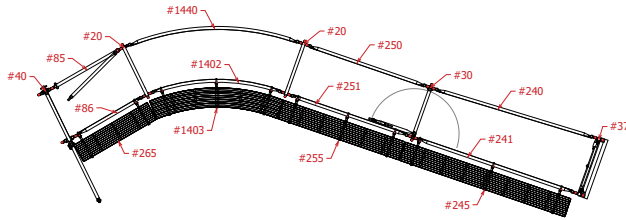

Walkways



#265*
4' Walkway
51 lbs



#1403
7'6" A1 Walkway
80 lbs



#255
7' Walkway
80 lbs



#245
9'3" Walkway
94 lbs



#1403
7'6" A1 Walkway
80 lbs



#255
7' Walkway
80 lbs

Spreader Frames

* Denotes Non-Stock Items



#30
32" Alley Spreader
Non-Adjustable
w/ Swing Door
79 lbs



#20
32" Alley Spreader
Non-Adjustable
41 lbs



#1420*
Adj. U-Alley
Spreader
Right Hand
217 lbs



#1410*
Adj. U-Alley
Spreader
Interior
174 lbs



#1430*
Adj. U-Alley
Spreader
Left Hand
217 lbs



#210
Adj. S-Alley
Spreader
Right Hand
185 lbs



#1425*
Adj. U-to-S
Alley Spreader
Right Hand
148 lbs

Spreaders with Door



#40
32" Alley Spreader
Non-Adjustable
w/ Rolling Door
180 lbs



#45
32" Alley Spreader
Non-Adjustable
w/ Bi-Fold Alley Gate
309 lbs



#37*
36" Alley Spreader
Non-Adjustable
w/ Lift-up Gate
110 lbs



#1427*
Adj. U-Alley
Spreader, Right
w/ Rolling Door
338 lbs



#1416*
Adj. U-Alley
Spreader, Interior
w/ Rolling Door
431 lbs



#1437*
Adj. U-Alley
Spreader, Left
w/ Rolling Door
338 lbs



#215
Adj. S-Alley
Spreader, Right
w/ Rolling Door
306 lbs











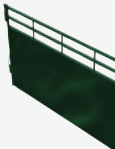

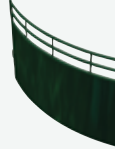

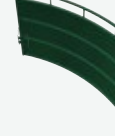
#1426*
Adj. U-to-S Alley
Spreader, Right
w/ Rolling Door
397 lbs

Nation Alley Parts

Adjustable S-Alley Parts

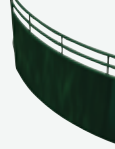
Alternate Alley Parts

<p>#1401! 9' U-Alley Section 168 lbs</p> 	<p>#240 9'-3" Alley Panel 195 lbs</p> 	<p>#180 10' S-Alley A Section 200 lbs</p> 	<p>#1340 10' S-Alley B Section 216 lbs</p> 
<p>#1402* 7'-6" U-Alley A1 Section 151 lbs</p> 	<p>#241 9'-3" Alley Panel 177 lbs</p> 	<p>#190 10' S-Alley A1 Section 197 lbs</p> 	<p>#1350 10' S-Alley B1 Section 181 lbs</p> 



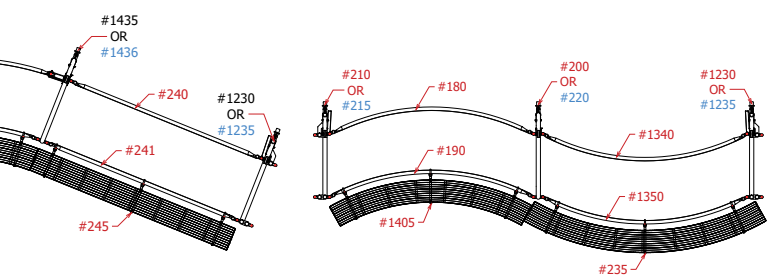







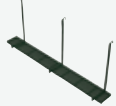

<p>#1342 7'6" S-Alley B Section 165 lbs</p> 	<p>#1375 7' Alley Frame w Gate 209 lbs</p> 	<p>#181* 12' S-Alley A Section 238 lbs</p> 	<p>#1341* 12' S-Alley B Section 258 lbs</p> 
<p>#1352 7'6" S-Alley B1 Section 139 lbs</p> 	<p>#239* 1'6" x 5' 6" high Sheeted Alley Panel 40 lbs</p> 	<p>#243 9'2" x 4' high Calf Alley Panel 129 lbs</p> 	<p>#244 9'2" x 80" high Calf Alley Panel 152 lbs</p> 









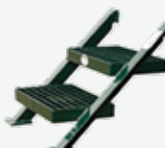

ROLLING DOOR



Hi-Hog's fixed width 32" wide rolling door is an extremely versatile option for any working alley. The door locks automatically when closed but can be released and opened quickly and easily from either side of the alley. Item **#40** - 180 lbs.

<p>#1403 7'6" A1 Walkway 80 lbs</p> 	<p>#245 9'3" Walkway 94 lbs</p> 	<p>#1405 10' A1 Walkway 94 lbs</p> 	<p>#235 10' B1 Walkway 105 lbs</p> 	
<p>#1435* Adj. U-to-S Alley Spreader Left Hand 148 lbs</p> 	<p>#1230 Adj. S-Alley Spreader Left Hand 185 lbs</p> 	<p>#210 Adj. S-Alley Spreader Right Hand 185 lbs</p> 	<p>#200 Adj. S-Alley Spreader Interior 117 lbs</p> 	<p>#1230 Adj. S-Alley Spreader Left Hand 185 lbs</p> 
<p>#1436* Adj. U-to-S Alley Spreader, Left w Rolling Door 397 lbs</p> 	<p>#1235 Ad S-Alley Spreader, Left w Rolling Door 306 lbs</p> 	<p>#215 Adj. S-Alley Spreader, Right w Rolling Door 306 lbs</p> 	<p>#220 Adj. S-Alley Spreader, Interior w Rolling Door 366 lbs</p> 	<p>#1235 Adj S-Alley Spreader, Left w Rolling Door 306 lbs</p> 

<p>#275 Walkway Transition 9.5 lbs</p> 	<p>#1406 Walkway Stairs 31 lbs</p> 	<p>#2285* Bison Scale Platform 436 lbs <i>*Special Order Call With Scale Make</i></p> 
<p>#3350* 24" Steer-Alley Spreader Non-Adjustable Primarily for rodeo use 38 lbs</p> 	<p>#3330* 18" Calf-Alley Spreader Non-Adjustable 29 lbs</p> 	<p>#170 Adjustable Alley Stop 45 lbs</p> 
<p>#3360* 24" Steer-Alley Spreader Non-Adjustable with Gate Primarily for rodeo use 71 lbs</p> 	<p>#59 18" Calf-Alley Spreader, Non-Adjustable w Lift Gate 47 lbs</p> 	<p>#60 18" Calf-Alley Spreader, Non-Adjustable w Side Tilt Gate 57 lbs</p> 

COMBINATION ALLEYS

Hi-Hog offers a range of sheeted straight alley panels that can be combined with U-Alley components to create custom non-adjustable and adjustable combination alleys, all built on Hi-Hog's Common Connector System for seamless integration and future expansion.

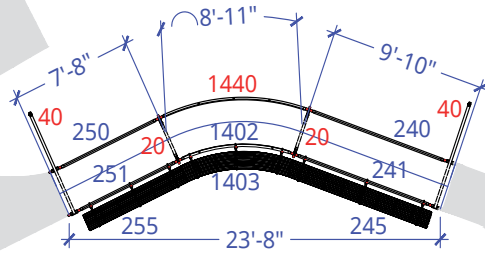

Non-Adjustable Combination Alley

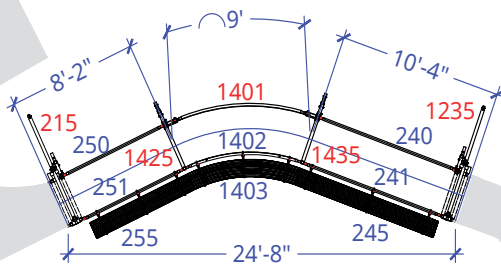

Adjustable Combination Alley

Non-Adjustable Combination Alley

A number of our standard alley panels can be combined with our fixed width alley spreaders to create a fixed 32" wide working alley.

Curved sections are created using a 1402 on the inside of the alley and a 1440 on the outside of the alley. Each curved section will change the direction of livestock flow by 45 degrees. Straight sections can be made by using any of our sheeted straight panels (4', 7', or 9'-3" in length).

Adjustable Combination Alley

Special transition spreaders (items #1425 and #1435) are used at the junction between straight and curved adjustable alley sections. These alley spreaders are also available with a rolling door (items #1426 and #1436, not shown).

The curved alley section should be installed on a firm, flat surface.

ADJUSTABLE U-ALLEYS

The curve of the U-Alley encourages livestock flow.

Each U-Alley section covers 45° of a circle.

The inside curved panel (#1402) is 60" high. The outside curved panel (#1401) is 66" high.

The length of each alley section (measured on the center line of livestock travel) is approximately 9'.

This compact system is most often used where physical space is limited.

For best results, the U-Alley should be set-up on a firm, flat surface. For improved animal and handler footing, we recommend installing on grooved concrete or paddock slab.

All of the U-alley spreaders are available with or without rolling doors.

Walkways, walkway stairs, and alley stops are also available.

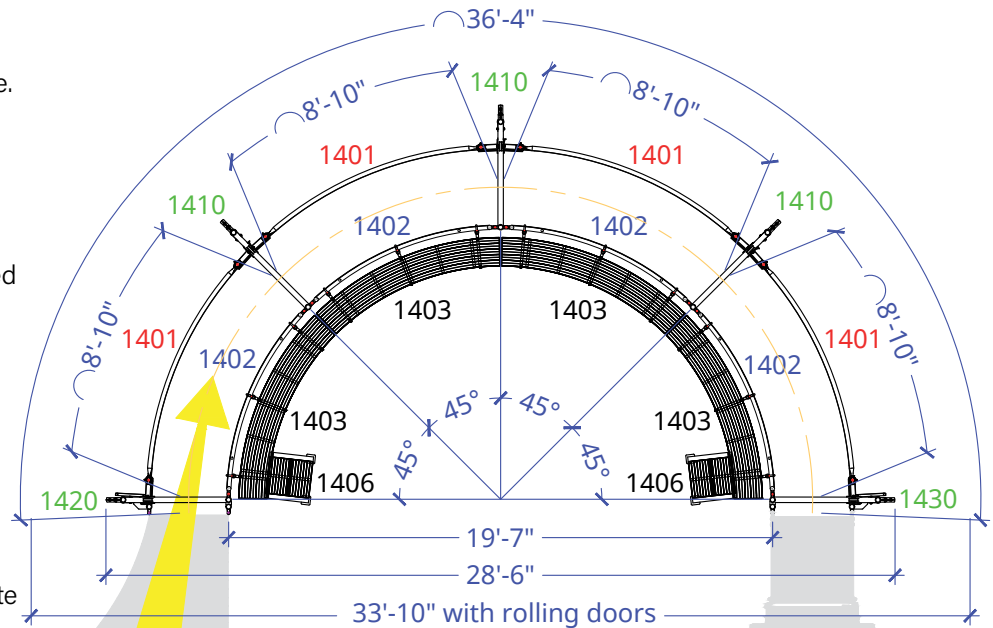

PIN-TO-PIN DIMENSION GUIDE

This page displays the pin-to-pin measurements on Hi-Hog's system components. You can use these measurements to estimate how much room you might need for your handling system. Please note that there is some play in each of the pin connections. Your handling system may be slightly longer or shorter. For a more accurate estimate please contact our help desk and we can prepare a scaled drawing based on your individual system requirements. Stock item numbers are **RED**. Non-stock, special order item numbers are shown in **GREEN**.

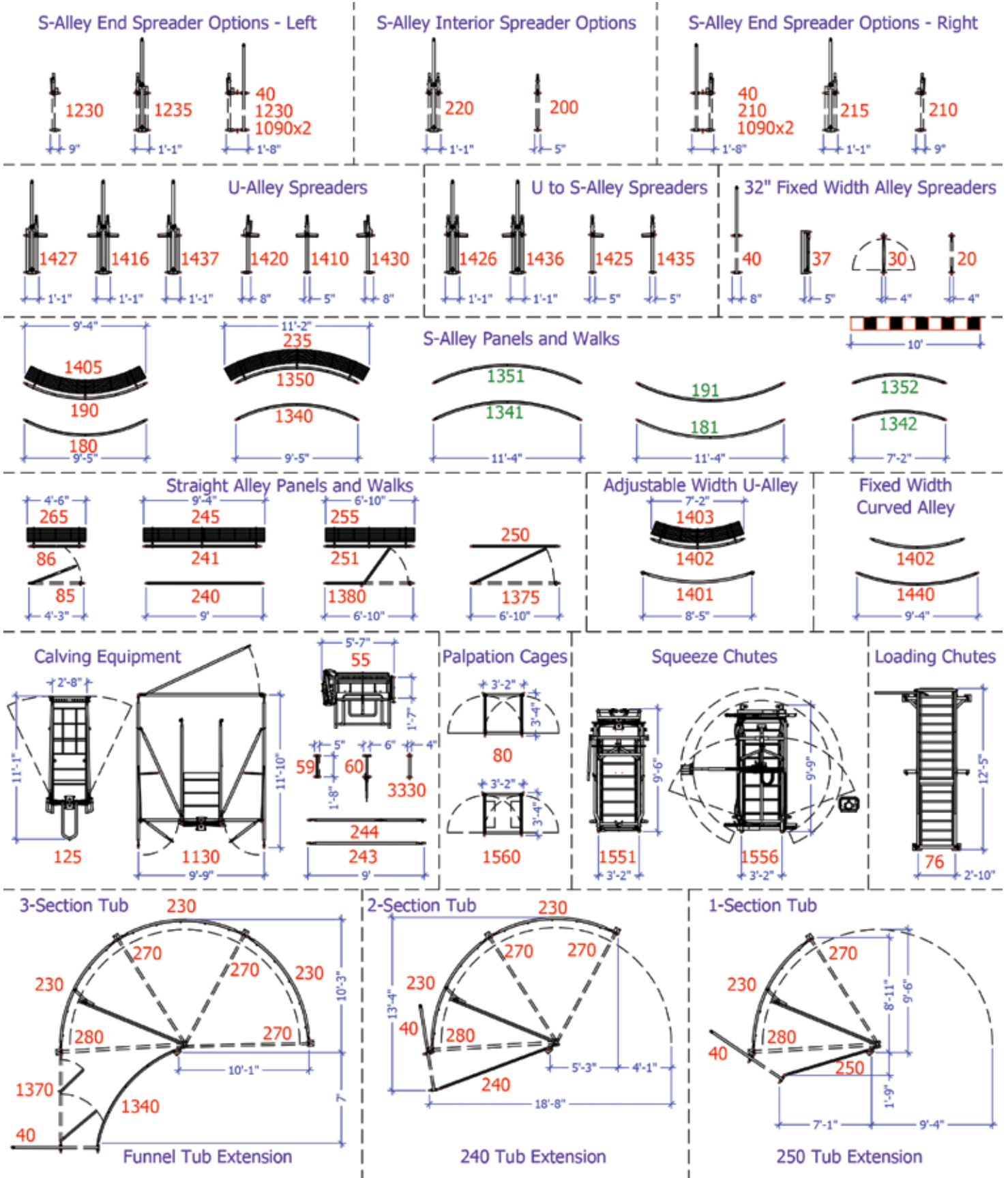

1 SQUARE = 1'-0" DESIGN WORKSHEET

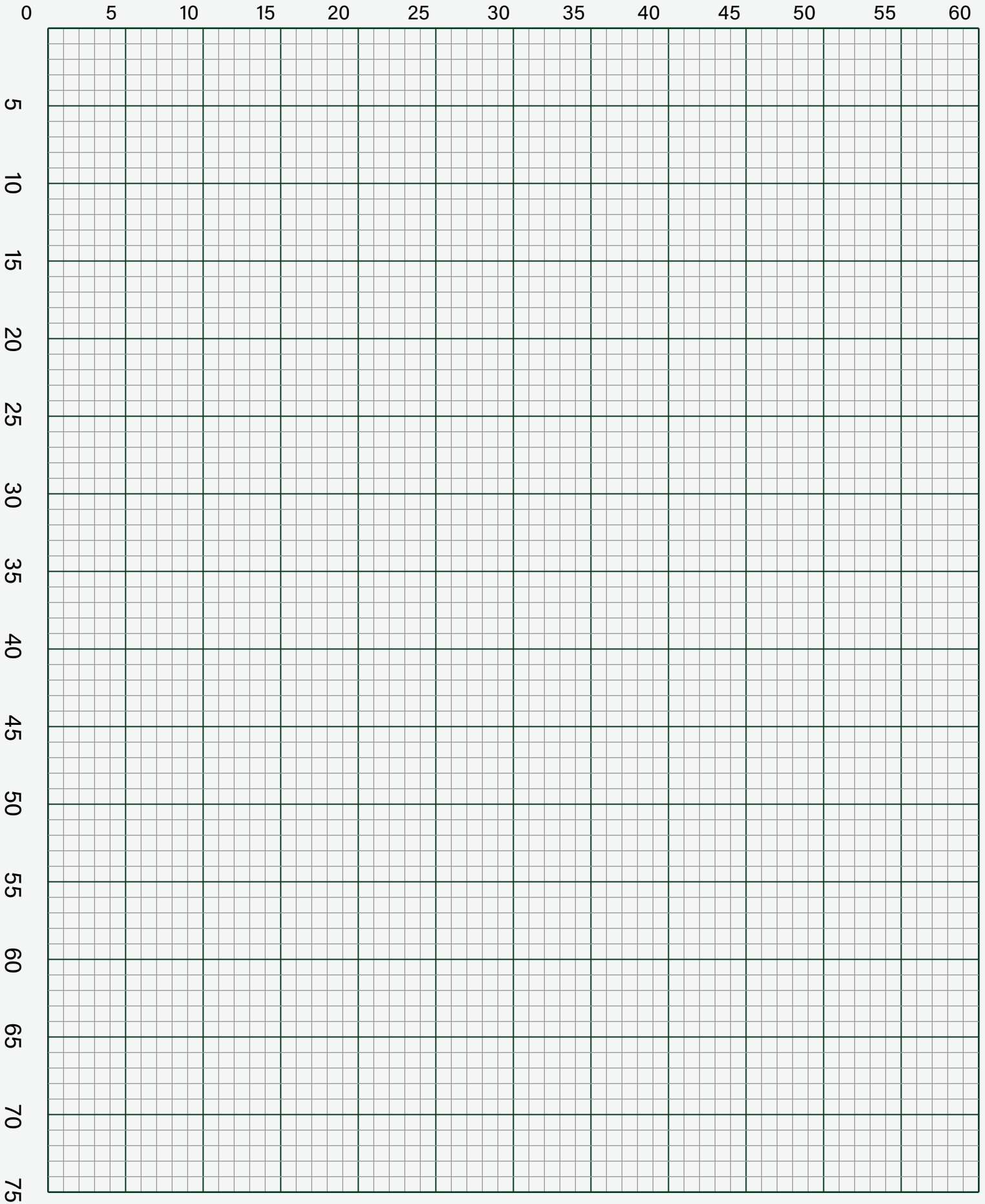



#1550 PARALLEL AXIS SQUEEZE CHUTE - 1536 - RH HEAD HOLDER



SAFE HANDLING. SMART DESIGN. YEAR-AFTER-YEAR RELIABILITY.

When Hi-Hog designed the Parallel Axis Squeeze Chute with Self-Catching Headgate, we built it smart — and built it to last. Engineered for safe, efficient livestock processing, the chute allows cattle to be caught without the operator standing at the front, reducing exposure to the animal's flight zone.

With the headgate set using the simple limiting chain, the operator remains free to work confidently from the alley. The addition of the optional Head Holder further enhances control, securely restraining the animal's head during procedures for safer, more precise handling.



S-ALLEY DESIGN - USING CATTLE'S NATURAL MOVEMENT

Hi-Hog's Adjustable S-Alley with Crowding Tub is engineered to improve safety, efficiency, and cattle flow. Designed to guide livestock smoothly from the Crowding Tub into the working alley, it reduces handling time while minimizing physical effort for the operator.

With adjustable width capability, the S-Alley accommodates a broad range of cattle sizes and breeds, delivering long-term adaptability as herd needs evolve.

Developed around natural livestock behavior, the curved alley design encourages forward movement with less hesitation. The result is calmer cattle, reduced stress, and more controlled, efficient processing.

Built on Hi-Hog's proven Common Connector System, these modular components can be combined, reconfigured, and expanded to create a handling system tailored to your ranch.

CATTLE WORKING ALLEYS - DESIGN ASSISTANCE

If you would like help developing a design for your cattle facility, call toll-free 1-800-661-7002. One of our experienced designers can prepare a complimentary scaled and itemized CAD drawing for you.

ADJUSTABLE S-ALLEYS

Curved system panels are connected to adjustable S-Alley spreaders to create an alley whose width can be adjusted from 32" down to 18". While the S-Alley is created with curved panels, the alley spreaders are positioned on a straight line.

The alley section made with items #180 and #190 is called an **A-section**, while the alley section created with items #1340 and #1350 is referred to as a **B-section**. The three section alley shown below is described as an **A-B-A** alley. A three section alley can also be made to be a **B-A-B** alley (see smaller drawing, below right).

Each of the adjustable S-Alley Spreaders are also available with a sheeted rolling door. Optional walkways and an alley stop are also available. The first section of S-Alley is 11' long. Each additional S-Alley section adds another 10'. The panel heights are either 60" or 66" high.

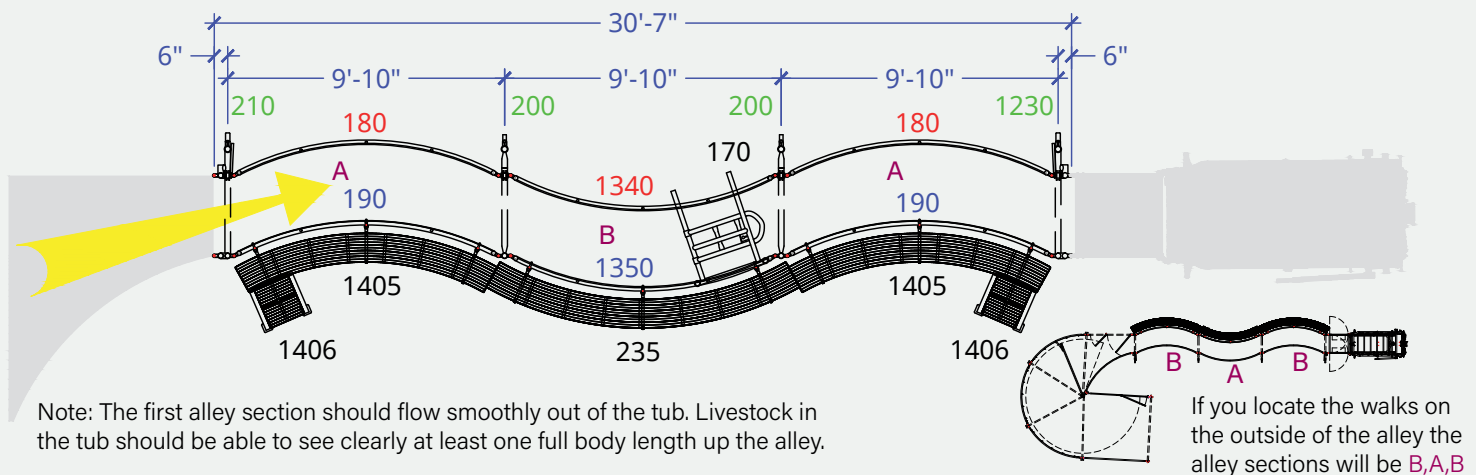

S-ALLEY ADJUSTABLE HANDLING SYSTEM

The Curved S-Alley was developed by Hi-Hog to take advantage of natural livestock behaviors. The result is an alley that cattle will enter and flow through with less hesitation and less stress.

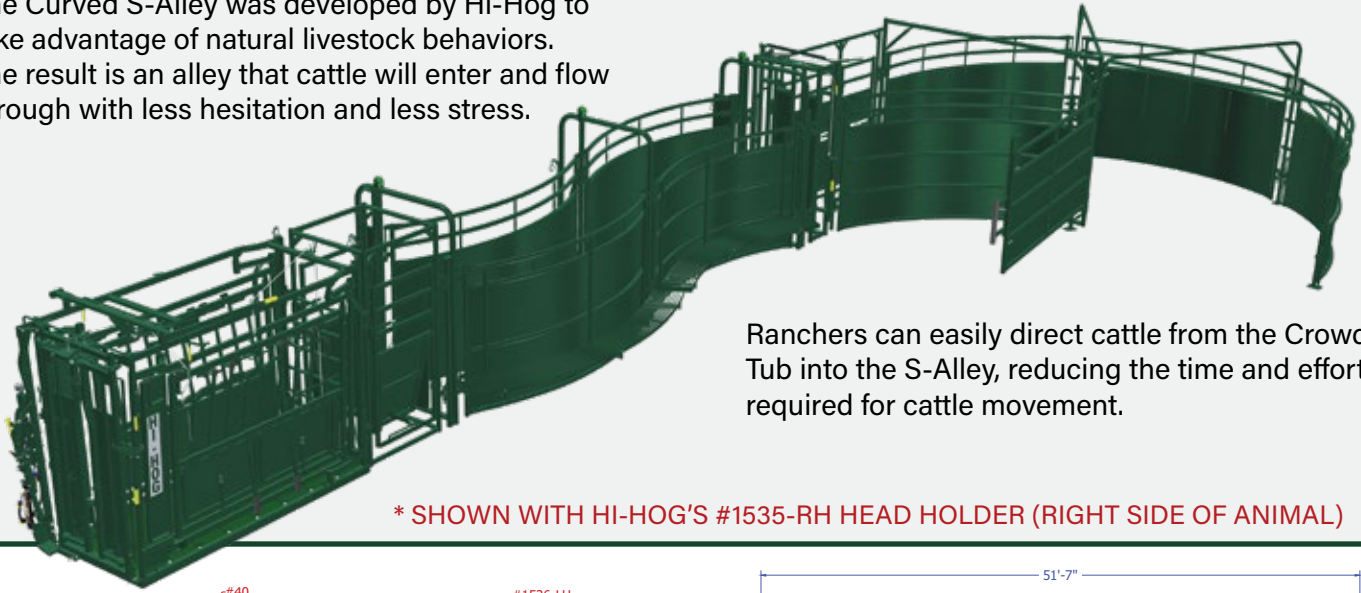

Ranchers can easily direct cattle from the Crowding Tub into the S-Alley, reducing the time and effort required for cattle movement.

* SHOWN WITH HI-HOG'S #1535-RH HEAD HOLDER (RIGHT SIDE OF ANIMAL)

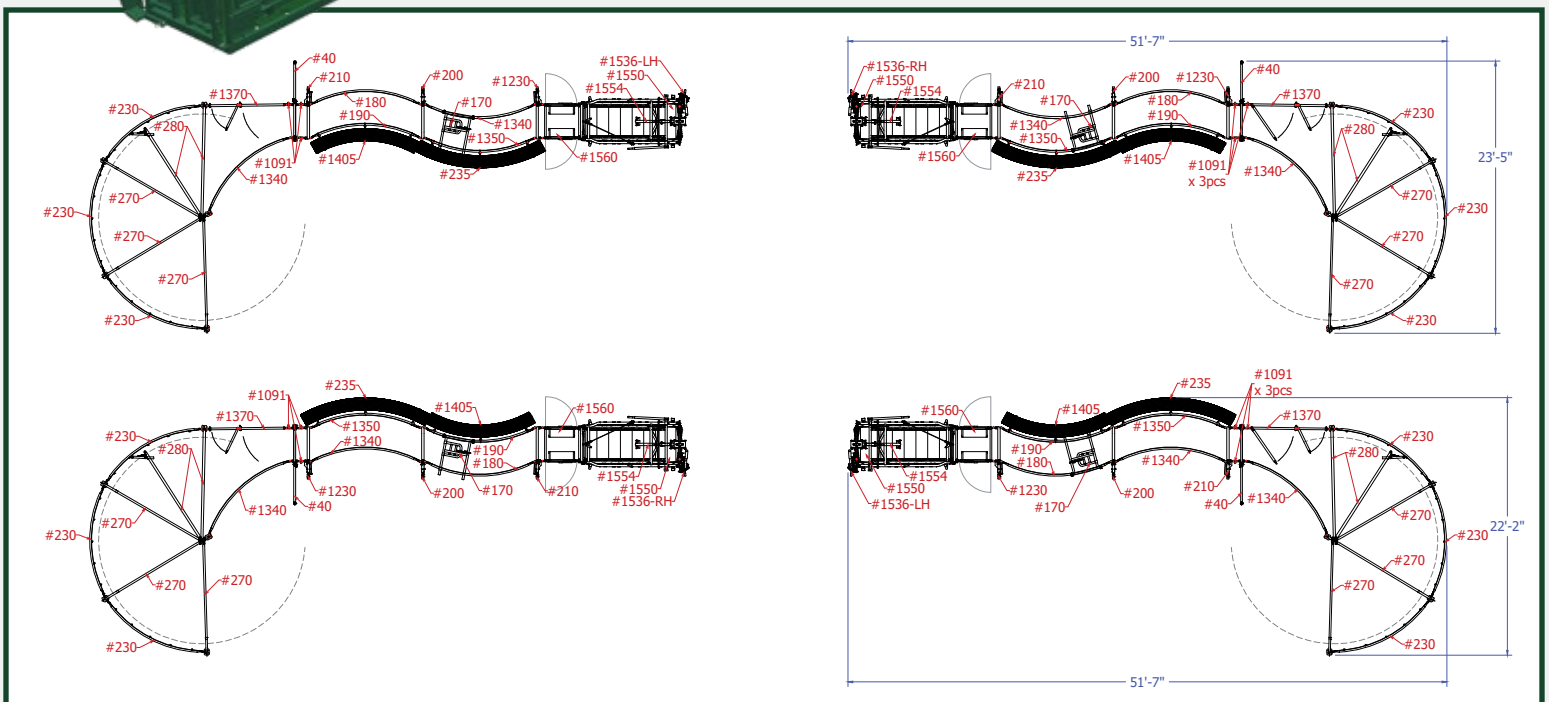

Improved Footing with Paddock Slab #1336

Two pallets of Paddock Slabs will provide safe footing for both animals and handler.

NOTE:

Paddock Slab must be filled with sand, soil, gravel or clay.

QTY	#	Description
3	1091	3 - Way Post 71.25" high x 1.9"
1	1230	Adjustable S-Alley Spreader - Left Hand
2	1340	Curved S-Alley Panel - 66" high - B
1	1350	Curved S-Alley Panel - 60" high - B1
1	1370	80" long 66" high Double Gate
1	1405	Walkway - Fits 190 & 1340
1	1550	Parallel Axis Squeeze Chute
1	1554	Sternum Bar
1	1560	Palpation Cage - Adjustable
1	180	Curved S-Alley Panel - 66" high - A

QTY	#	Description
1	190	Curved S-Alley Panel - 60" high - A1
1	200	S-Alley Adjustable Alley Spreader - Interior
1	210	S-Alley Adjustable Alley Spreader - Right
3	230	Crowding Tub Curved Panel
1	235	Walkway - Fits 1350 & 180
3	270	Overhead Spreader for Crowding Tub
1	280	Pivot Gate with Tub Spreader
1	40	Fixed Width Rolling Door - for 32" alley
1	170	Alley Stop
1	1535	LH or RH Optional Head Holder (LH or RH side of animal)

DOUBLE ALLEY HANDLING SYSTEM

The Hi-Hog Adjustable Double Alley with Return Box is engineered to deliver rapid, controlled livestock movement within a complete cattle handling system. Cattle are directed smoothly from the Return Box into the Adjustable Double Alley, improving efficiency during tagging, sorting, loading, and routine herd health procedures. This controlled cattle flow reduces stress on livestock while saving valuable time and labour in demanding ranch environments.

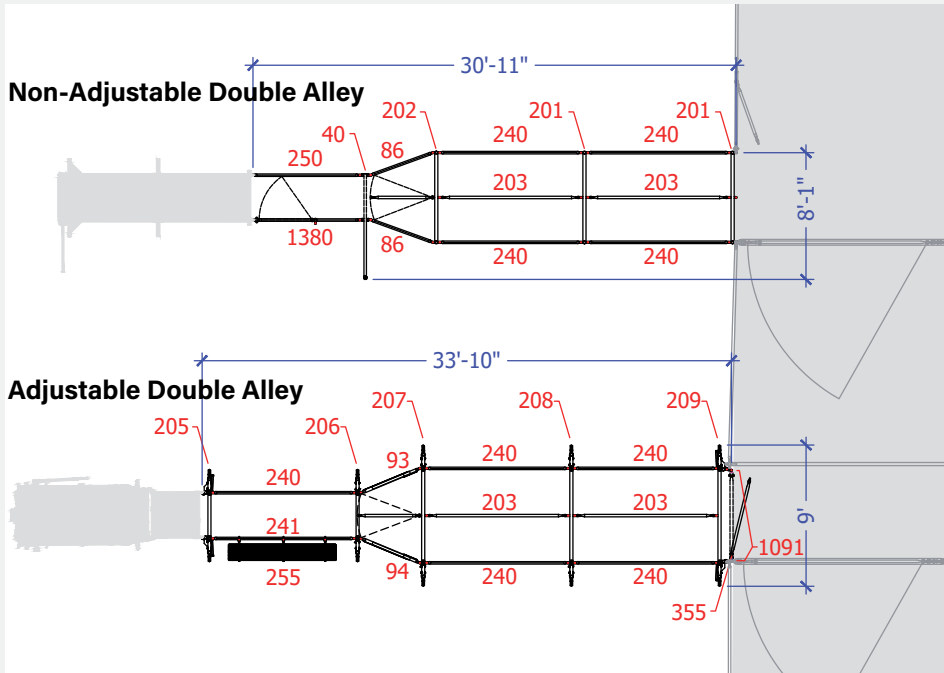

The double alley offers a large opening so cattle can locate and enter the alley quickly using a #355 frame and gate as an alley barrier.

#	Description	Weight Lbs
201	Double Alley Spreader	104
202	Double Alley Spreader w Sort Gate	156
203	Double Alley - 6-Bar Open, 9'-3" Center Panel	108
240	9'-3' Sheeted Alley Panel	195
205	32" alley end spreader w twin controls	265
206	32" alley interior spreader w twin controls	164
207	Double Spreader w Sort Gate-Adj Width	263
208	Double Spreader-Interior-Adj Width	211
209	Double Spreader-End-Adj Width	310
86	P.A.S.S. Panel	96
93	Sheeted Expanding Panel - Right Hand	181
1091	6' - 3 - Way Connector Post	10.8
355	8' Frame w 6' Gate open bar Frame and Gate	155
94	Sheeted Expanding Panel - Left Hand	181

* SHOWN WITH HI-HOG'S #1535-RH HEAD HOLDER (RIGHT SIDE OF ANIMAL)



HI-HOG ADJUSTABLE DOUBLE ALLEY WITH A RETURN BOX

When integrated with an Adjustable Palpation Cage and a manual or hydraulic Squeeze Chute with three-way sorting, this double alley cattle handling system supports steady, uninterrupted cattle movement. The result is improved processing speed and safer livestock handling—ideal for high-volume operations and repeat handling applications.

Built around Hi-Hog's Common Connector System, this modular cattle handling equipment is fully customizable to suit the needs of your operation. Additional sorting options, load-out configurations, and future system expansions can be seamlessly incorporated, allowing your livestock handling system to adapt and grow alongside your ranch.

2026 - HI-HOG ULTIMATE HANDLING SYSTEM

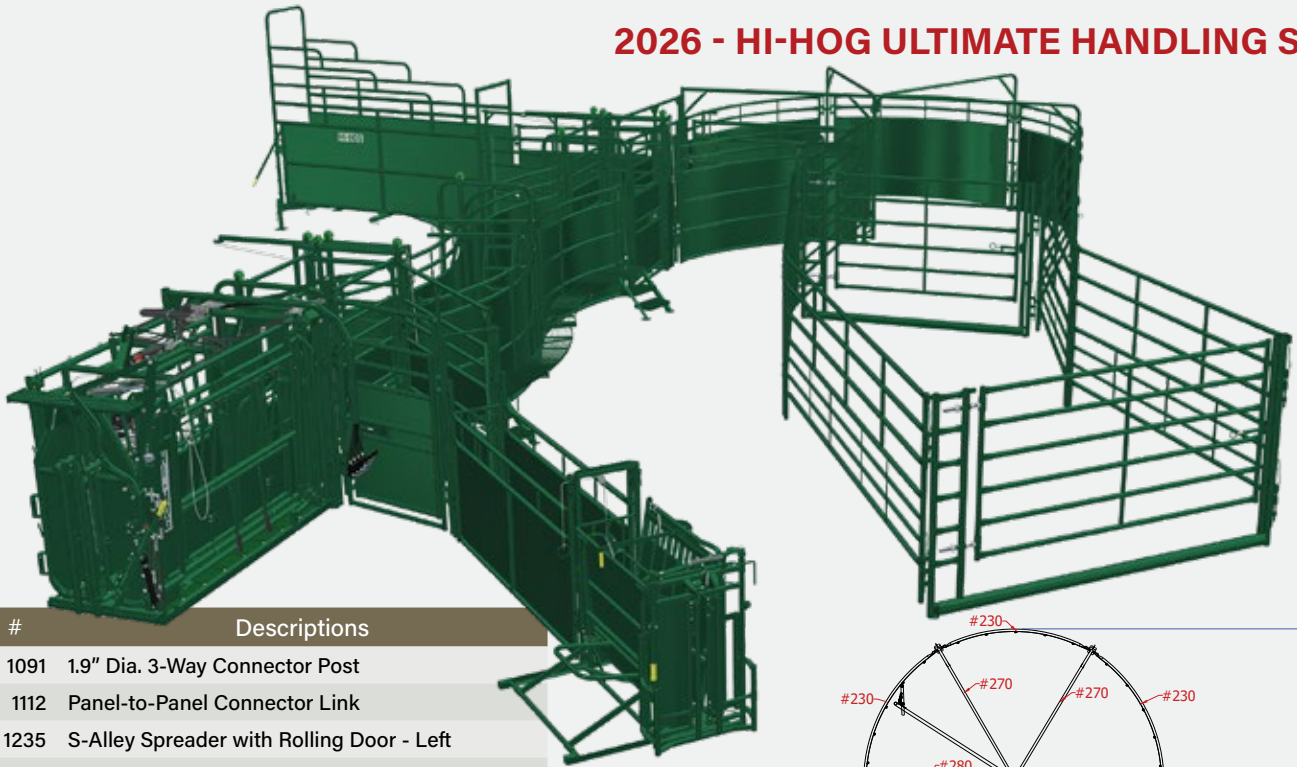

Qty	#	Descriptions
3	1091	1.9" Dia. 3-Way Connector Post
2	1112	Panel-to-Panel Connector Link
1	1235	S-Alley Spreader with Rolling Door - Left
2	1340	Curved Sheeted Panel - B - 66" high
1	1350	Curved Sheeted Panel - B1 - 60" high
1	1370	Straight Sheeted Panel - Double Gate
2	1380	Straight Sheeted Panel - Sorting Gate
1	1405	Curved Walkway - A1
2	1406	Walkway Stairs
1	1535	Head Holder 1535-LH - On LH side of animal
1	1556	Hydraulic Squeeze w Electric Powerpack
1	1554	Sternum Bar
1	1744	U-Spreader - 10' long x 6' high
1	180	Curved Sheeted Panel - A - 66" high
1	190	Curved Sheeted Panel - A1 - 60" high
2	200	S-Alley Spreader - Interior
1	210	S-Alley Spreader - Right
1	220	S-Alley Spreader with Rolling Door - Interior
3	230	Curved Sheeted Tub Panel - 66" high
1	235	Curved Walkway - B1
2	243	Straight Sheeted Panel - Calf Alley
1	250	Straight Sheeted Panel - 80" long x 66" high
3	270	Overhead Tub Spreader
1	280	Pivot Gate with Tub Spreader
1	312-6	U-Frame Gate Support - 12' long x 6' high
1	55	Calf tipping table with integrated neck extender
1	60	Calf-Alley Spreader with side tilt gate
1	6751	Heavy Duty Gate - 10' long x 5' high w plunger
1	76	Stationary Loading Chute
1	836	Heavy Duty Panel - 10' long x 6' high
1	846	Heavy Duty Panel - 12' long x 6' high
1	847	Heavy Duty Panel with Gate - 12' long x 6' high
5	85	Palpation and Sorting Section (PASS) Gate
1	856	Heavy Duty Panel - 14' long x 6' high
1	866	Heavy Duty Panel - 16' long x 6' high

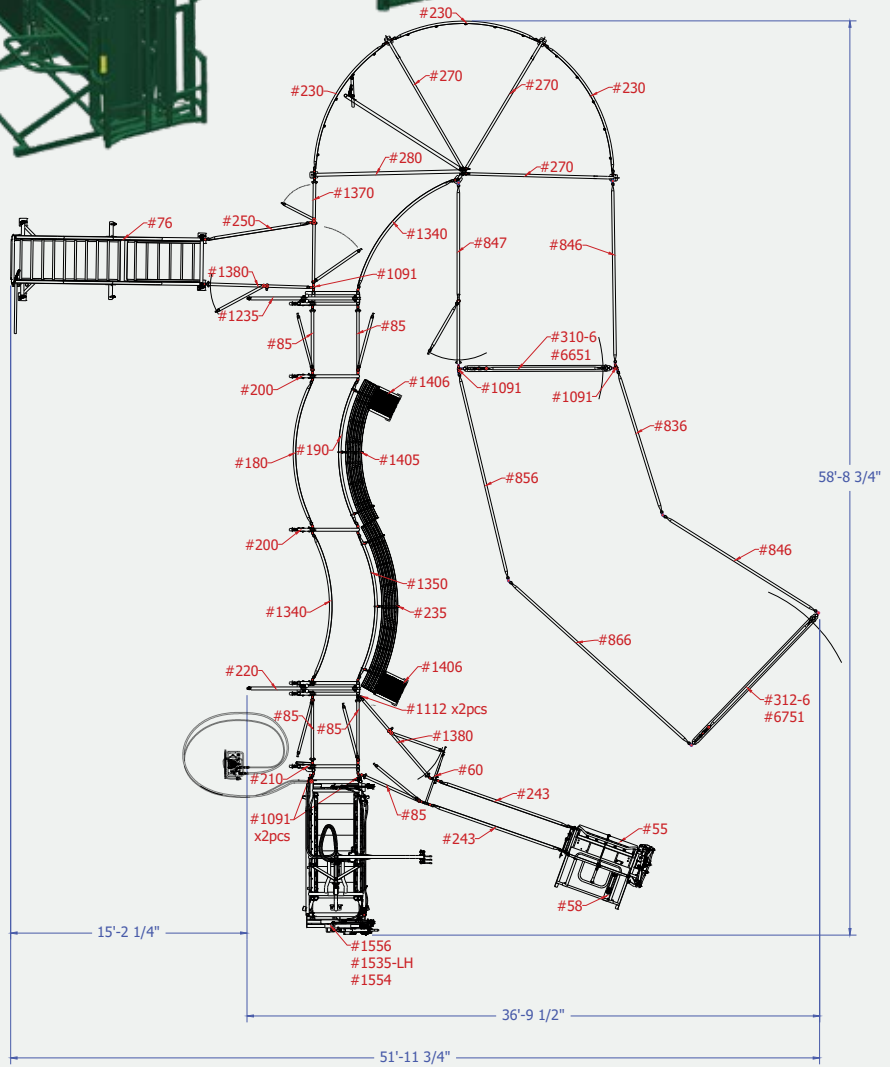

Built for serious cattle operations, Hi-Hog's Ultimate Cattle Handling System delivers controlled cattle flow, rugged, heavy-duty steel construction, and modular adaptability—helping ranchers work smarter, reduce stress on livestock, and operate with greater safety and efficiency. Providing long-term value for progressive ranch operations.

CALVING / MATERNITY TUB



Hi-Hog's Maternity Tub combines the proven #125 Calving / Trimming Chute with a secure, fully sheeted crowding system to provide controlled, safe calving conditions. Engineered for stability in high-pressure environments, this heavy-duty steel system delivers complete animal access, smooth cattle flow, and reliable performance during critical calving operations.

MODULAR. EXPANDABLE. RANCH-READY.

Hi-Hog Common Connector System

- Calving / Maternity Tub components integrate seamlessly with your cattle handling system
- Curved panels convert into a working Crowding Tub
- Pivot gates reposition for year-round use
- No seasonal downtime — no duplicate equipment

One system. Multiple uses. Built for long-term value.

BUILT FOR SAFE, CONTROLLED CALVING

Core Component – #125 Calving / Trimming Chute

- Split-panel design provides complete cow access from both sides
- Ideal for assisted calving, trimming, and veterinary procedures
- Allows quick, controlled access during high-pressure situations

Crowding Tub Section

- Constructed with #230 – 66" high sheeted curved panels
- Secured with #270 Overhead Tub Spreader
- Designed to promote smooth cattle flow into the chute

Secure Anchoring System

- High-pressure area engineered for stability
- #280 Pivot Gate frame and overhead spreaders designed with anchoring provisions
- Anchor through base plates when installed on concrete
- Includes 24" ground stakes for non-concrete installations to prevent movement

Heavy-Duty Pivot Gate

- Solid pivot gate mounted in its own frame
- Hinges: 2-7/8" OD x 4" with grease fittings for long-term performance
- Rubber-coated, spring-loaded latch for smooth, quiet operation
- Reversible latch for clockwise or counter-clockwise swing

Adjustable Configuration

- Modify spacing at front or rear using the #239 Sheeted Filler Panel
- Optional second #239 allows tighter connection to the #1375 Gate Section
- Designed for layout flexibility within your calving facility

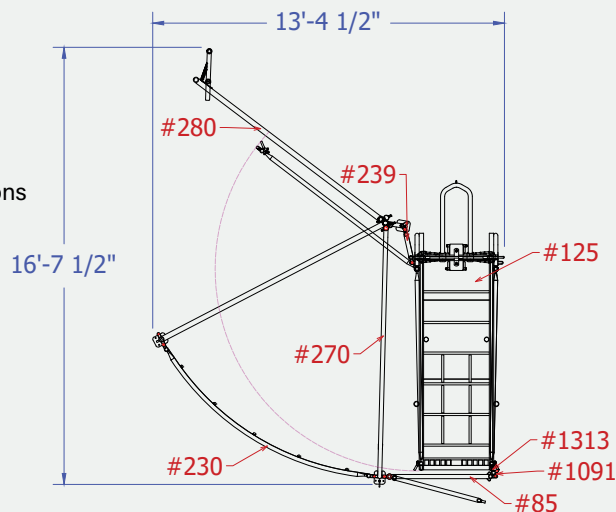

CALVING / MATERNITY TUB SUGGESTED LAYOUT

Description	#	Weight (lbs)
Calving / Grooming Chute c/w Nose-Bar	125	791
239 (1 or 2) 16" Sheeted Alley Panel	239	40
Pivot Gate c/w Pin	280	435
Overhead Tub Spreader c/w Pin	270	46
Curved Tub Section	230	209
Tub Section Straight with 7' Gate	1375	209
3/4" OD x 48" Connector Pin	1313	3
Connectors 3-Way-6'	1091	11
P.A.S.S. Gate- Palpation Frame & Gate	85	130

80.5" Clearance

CALVING / TRIMMING CHUTE



44" Outside Width



108" Overall Length

64" Rear Height

Calving / Trimming Chute Item #125

- Versatile, Multi-Purpose Design

Ideal for calving heifers, grooming show cattle and performing general veterinary treatments.

- Full Access to Both Sides of the Animal

Upper and lower split side panels provide controlled access exactly where and when it's needed.

- Flexible Split Panel Configuration

Upper and lower split panels can be latched together to form a single, solid side panel for full containment.

- Rugged Self-Catch Headgate Included

Equipped with Hi-Hog's positive-locking self-catch headgate to securely restrain the animal, single handed.

- Enhanced Safety for Cattle and Handlers

Controlled restraint helps minimize stress and lowers the risk of injury during calving, treatment, and grooming.

- Heavy-Duty Checker Plate Floor

Reinforced steel floor with traction bars provides excellent footing.

- Secure Panel Control System

Ratcheted floor stops and allow split panels to be held tight and secure during use.

- System-Ready Corner Connectors

Allow seamless connection into a maternity tub or any Hi-Hog common panels.

Calving/Trimming Chute

Description	#	Weight (lbs)
Calving/Trimming Chute	125	791
Head Tie-up Bar	126	16

HEAD TIE BAR

Item #126, 16 Lbs



The Head Tie Bar is designed to mount directly to the frame of both the Calving Headgate and PA Squeeze Self Catch Headgate.

Included with #125 Trimming Chute

CALVING ENCLOSURE / MATERNITY PEN

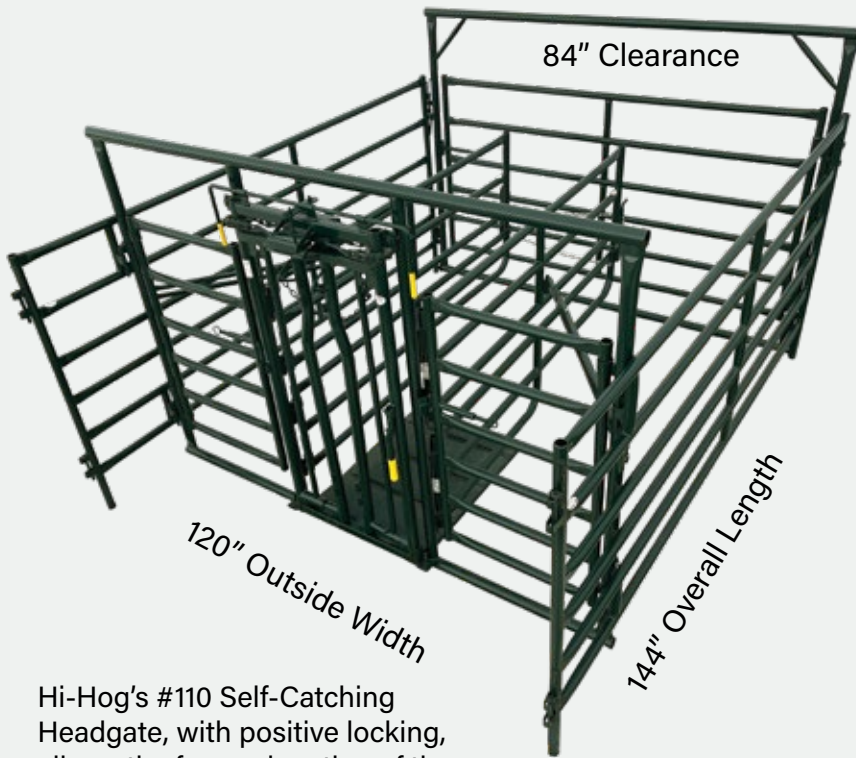

Hi-Hog's #110 Self-Catching Headgate, with positive locking, allows the forward motion of the cow to firmly catch and lock itself into the Enclosure.



Centred Self-Catch Headgate
Complete Animal Access on Both Sides



Multiple Rear Split Panel Locking Options

Standard Calving Enclosure - complete, Item #1130 with optional #1146 Skid Platform

Hi-Hog's Calving Enclosure with center mounted Self-Catch Headgate provides unmatched accessibility in a stable structure.

The self-catch headgate with adjustable stanchions is centered in the front panel of the calving enclosure to provide unmatched access to your cow. Ideal for milking out on one side while a calf sucks on the other side.

Access gates, on both sides of the headgate, come with self-locking plunger latches for quick and secure access. The pen comes with split side panels mounted to the front frame that can be swung to the sides to assist in catching the cow and providing a safe zone for the handler.

Folding braces allow you to position the split panels beside your cow and lock them securely. Two 1/4" x 48" chains with quick links are included to lock the Split Panels.

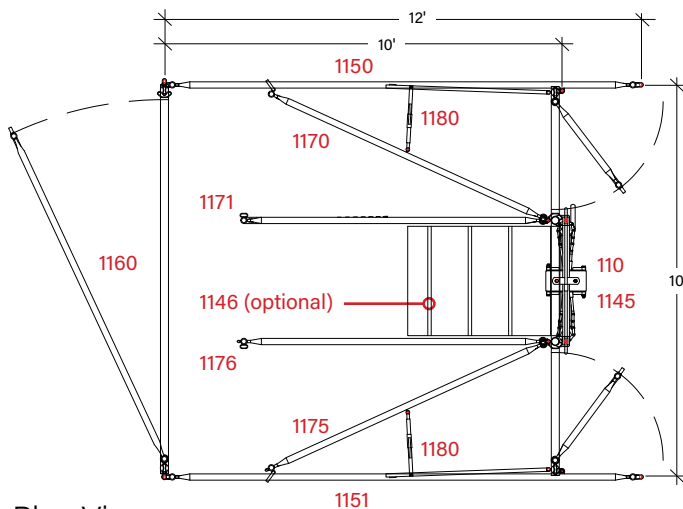

Plan View

Calving Enclosure		
Description	#	Weight (lbs)
Standard Calving Enclosure (complete)	1130	1096
Self-Catch Calving Headgate	110	239
Front Enclosure Frame	1145	221
12' Left Side Panel	1150	112
12' Right Side Panel	1151	112
Split Panel - Top Left	1170	54
Split Panel - Top Right	1175	52
Split Panel - Bottom Left	1171	43
Split Panel - Bottom Right	1176	41
10'w x 7'h Calving Frame & Gate	1160	196
Folding Brace - 2 required	1180	15
Optional Skid Platform	1146*	72

CALF ALLEY

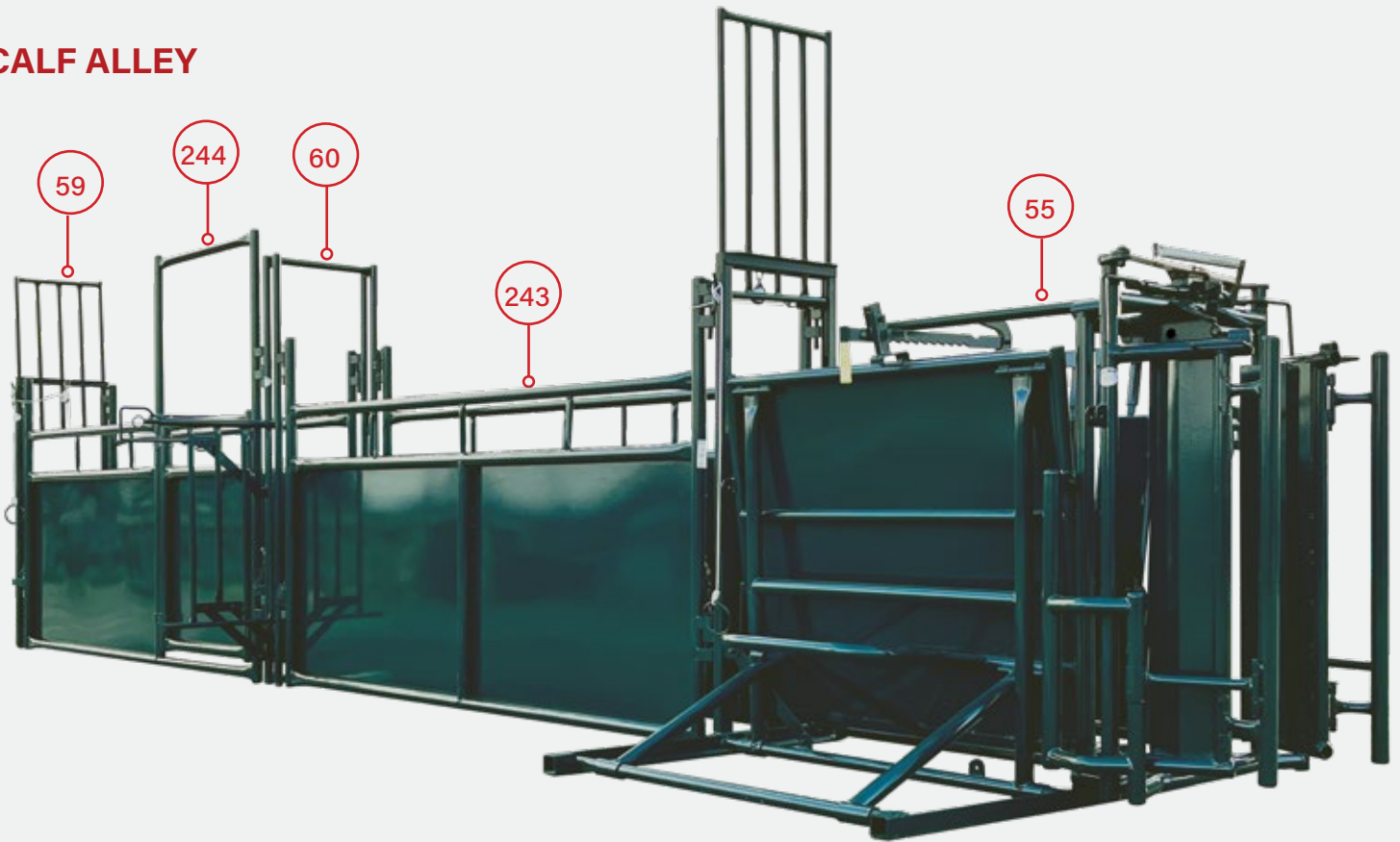

Reduce Labor, Increase Throughput – Move more calves in less time with a Calf Alley that prepares them perfectly for treatment, branding, or tagging in the Tipping Table.

The sheeted side panels on the Calf Alley keep your calves focused on the path forward while keeping nose and toes safely inside. The sheeted panels are low enough for you to easily reach your calves.

Calf Alley Spreader with Lift-up Gate, #59, 47 Lbs.

The lift-up gate in frame is operated by rope, allowing the handler to position themselves in the best location to effectively and efficiently move their stock. Connects with all Hi-Hog panels to make an 18" wide alley. Perfect for handling calves and small animals.

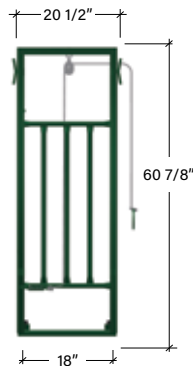

Calf Alley Spreader with Side-tilt Gate, #60, 57 Lbs.

The side tilt calf alley gate locks in the closed position.

The additional interior clearance provided by this calf alley spreader makes it the preferred choice for those who work their calves from inside the alley.

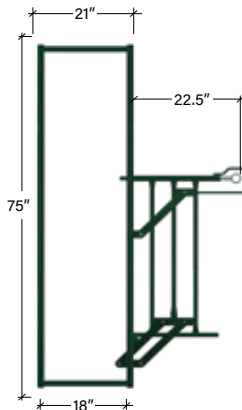

Calf Alley Spreader - Plain, #3330, 29 Lbs.

Like the side-tilt gate, the plain calf alley spreader provides better clearance for those who wish to work their calves from inside the calf alley.

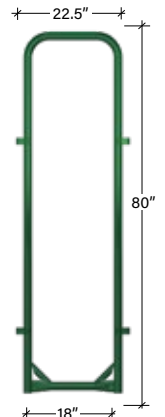

Calf Alley Panel, #243, 129 Lbs.

The inside of the alley is finished with 16 gauge sheet metal to keep your calves focused on the path forward. The 48" height makes it easy to reach into the alley.

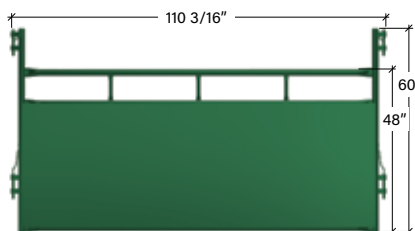

Calf Alley Panel with Gate, #244, 152 Lbs.

Built the same as the calf alley panel (Item #243) but with an access gate for the handler. The access gate comes with a simple and secure gravity latch.

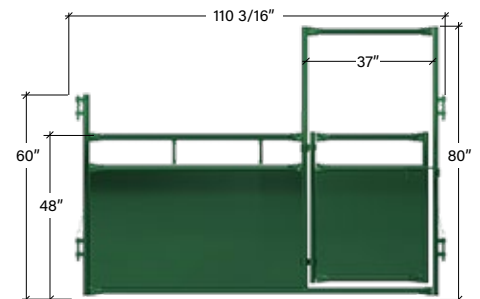

- Self-Catching, Positive Locking auto Headgate
- The Headgate opens wide for easy release
- Headgate can be locked open
- Headgate comes with neck extender for superior control
- Fully reversible for left or right hand brands
- Squeeze and tip in one easy well balanced motion
- Adjustable bottom width to hold a variety of weights and stock
- Pin the calf alley directly the tailgate which does not tip



34" width

68" length

CALF TIPPING TABLE

- Six independent spring loaded side access panels swing down for safe, fast access to the full length of your animal
- Access panels are sheeted to keep feet safely inside
- Foot panel swings up to provide clear access to the feet (the foot panel is also removable)
- Equipped with convenient tie loops for securing legs
- Heavy duty all steel construction
- Quality fit and finish
- Table can be locked in upright position

62" high

Calf Tipping Table with Neck Extender Item # 55, 472 Lbs.

Calf Sorting Gate

#382, 302 Lbs. Frame dimensions = 139 1/2" wide x 96" high



Hi-Hog's Calf Sorting Gate can help you sort your calves with a minimum of stress. The heavy-duty livestock gate can be used as a traditional pen gate throughout the year. When you're ready to sort your calves, you simply open the bottom half of the gate to allow your calves to flow through, with minimal stress.

The height of the gate is adjustable. This allows you to set the height of the gate opening to match the needs of your operation. Set the height of the opening to be just below the shoulder height of your calves. The gate has seven height settings.

Calf Tipping Table

#55 + #58 Hydraulic Tip Kit, 509 Lbs.



Hydraulic Tip Kit

#58, 37 Lbs.

An optional add-on Hydraulic Tipping Kit can be bolted directly to Hi-Hog's calf tipping table. (item #55). The Valve and Pump are not included, but can be attached to the spare valve on Hi-Hog's Hydraulic Squeeze Chutes. [page 11](#)

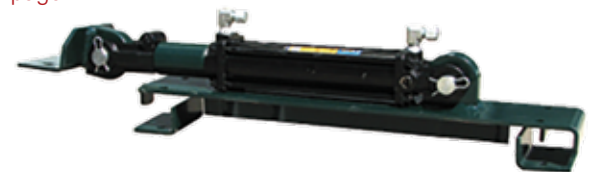

Paddock Slab - #1336

Coverage = 2.11 ft²/tile

0.1957 m²/tile

Tile depth = 1.56"

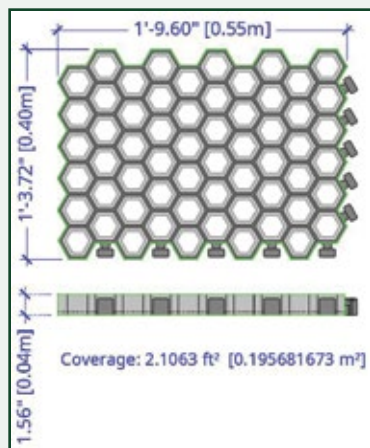

Stable Interlocking design

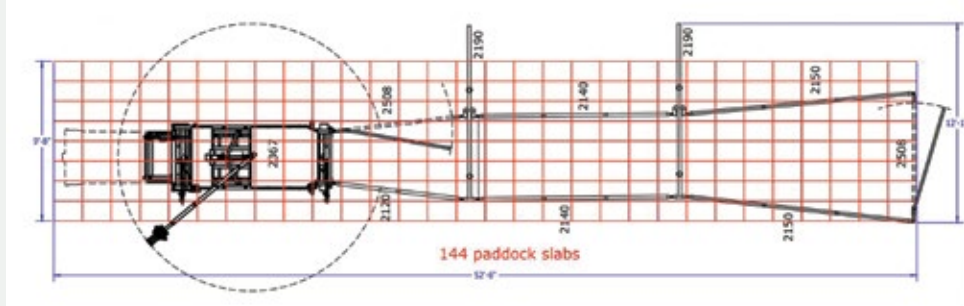

Paddock Slab Added to a Bison Alley Design



Learn more about Paddock Slab porous ground stabilizing tiles. Scan the QR code for Hi-Hog's web-site.

Multi-purpose Paddock Slab, porous tile has a wide range of uses for multiple industries. Equine Paddocks, Livestock System Bases, or Landscaping. Paddock Slab's permeability, load bearing strength, and ability to lock fast with other tiles creates a smooth, continuous, erosion resistant grid. NOTE: Paddock Slab must be filled with some sort of sand, soil, pea gravel or clay. 1 yard of Pea Gravel will provide coverage for 120 pieces of Paddock Slab.



Arena Footing Base



Erosion and Mud Protection



Handling System Footing

Special Order - BULL TIPPING TABLE

Item #95 - 2850 Lbs

Hi-Hog's Hydraulic Bull Tipping Table is a valuable tool. Primarily used for bovine hoof treatment and hoof trimming.

The table is also used for examining and treating injuries and problems with a bull's genitals or a cow's udders.

The animal walks through the open area between the padding. Once in position the animal is restricted and calms down and can be tilted with the Hydraulic Controls.

*Call 1-800-661-7002 for Bull Table Availability.



HANDY PANELS:

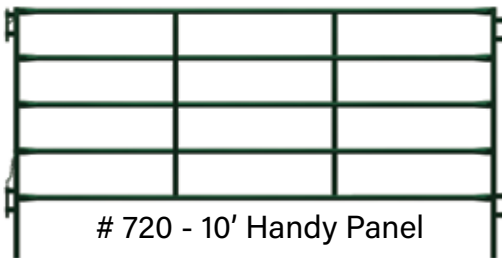

720 - 10' Handy Panel

- Designed to be used wherever you need a barrier.
- Light weight and Portable with our standard Pin and Chain common connections.
- Ideal for low pressure animal segregation and Wellhead Protection.
- Handy Panels are constructed with 1-5/16" - 16 gauge High Tensile North American Steel Tubing, with 3/16" flat interior vertical supports.
- Durable Polyester Powder Coat Paint finish.

CORRAL PANELS:

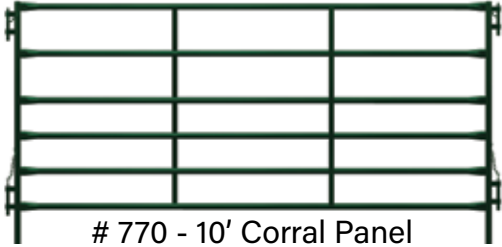

770 - 10' Corral Panel

- Designed for use in Holding Corrals
- The Narrow Spacing on the four bottom bars provides added Calf control. Suited for Equine and non-alley Cattle Corrals.
- Corral Panels are constructed with 1-1/2" - 16 gauge High Tensile North American Steel Tubing, with 3/16" flat interior vertical supports.
- Durable Polyester Powder Coat Paint Finish.
- Available in 5' and 6' heights.

HEAVY DUTY PANELS:

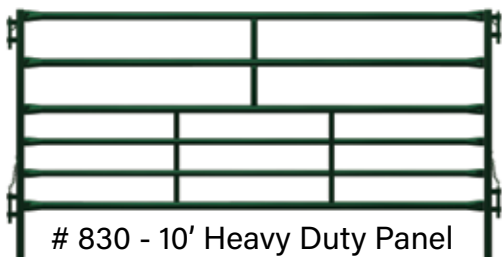

830 - 10' Heavy Duty Panel

- Designed for use in High Pressure Areas, such as Working Corrals and Handling Facilities.
- Narrow Spacing on the four bottom bars for Calf control.
- Heavy Duty Panels are constructed with 1.9" - 14 gauge and 1-1/2" 16 gauge High Tensile N. A. Steel Tubing and steel tubing interior supports.
- Heavy Duty panels are available in 5', 6' and 7' heights.
- All Hi-Hog Panels have a Durable Powder Coat Paint Finish.

HANDY GATES:

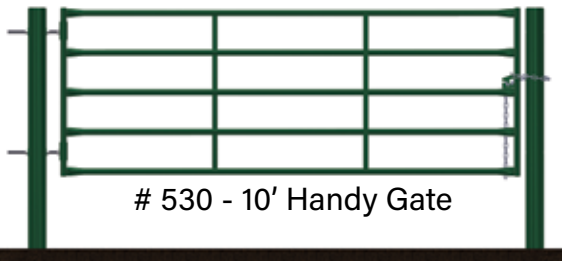

530 - 10' Handy Gate

- Designed for low pressure uses such as acreage gates or in tandem with Hi-Hog Cattle Guards.
 - Handy Gates are constructed with 1-1/2" - 16 gauge High Tensile North American Steel Tubing. Coned verticals remove sharp edges.
 - Horizontals are reinforced with 1.25" x 3/16" flat bar.
 - Handy Gates have two 13" x 3/4" All-thread hinges.
- 16', 18' and 20' handy gates come with 13" x 1" All-thread 1.9" dia., hinge collars.

CORRAL GATES:

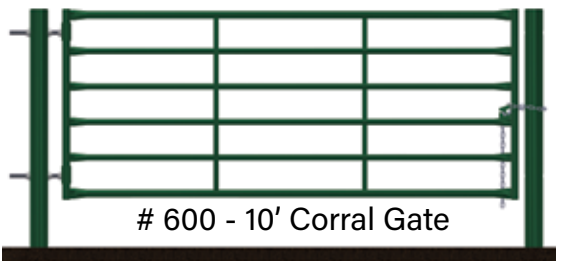

600 - 10' Corral Gate

- Designed for moderate pressure uses such as corrals.
- The top, bottom, and end verticals are constructed of 1.9" OD, 14 gauge tubing. Interior horizontals are constructed of 1.5" OD, 16 gauge tubing. Coned Verticals remove sharp edges.
- Reinforced with 1.25" x 3/16" flat bar. Corral Gates have two 13" x 1" All-thread hinges.
- All gates includes 48" of 1/4" zinc plated chain and a no-slip chain latch.

HEAVY DUTY GATES:

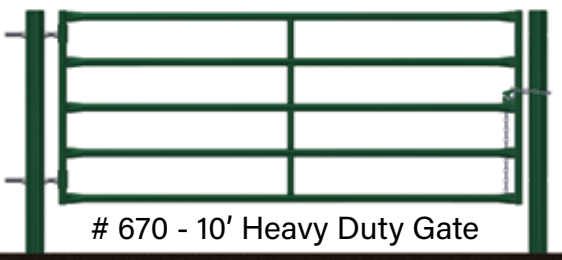

670 - 10' Heavy Duty Gate

- Heavy Duty Gates are primarily used in livestock handling applications.
- Constructed of 1.9" OD 14 gauge High Tensile North American Steel Tubing. Coned Verticals remove sharp edges.
- Reinforced with 1 1/2" OD 16 gauge tubing. Coped to fit the horizontals.
- Heavy Duty Gates comes with two 13" x 1" All-thread hinges on four inch collars. 48" of 1/4" zinc plated chain and a no-slip chain latch.
- Available in 4', 5' and 6' heights.
- All Hi-Hog Gates have a Durable "Hi-Hog Green" Powder Coat Finish.

PANELS - CONNECTORS - POSTS

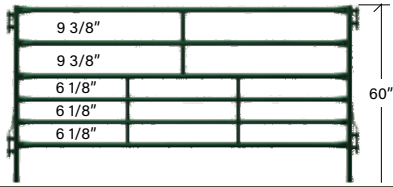

5' High Heavy Duty Panel - 6 Bar		
Length	#	Weight (lbs)
4'	808*	49
6'	810	69
8'	820	87
10'	830	104
12'	840	124
14'	850	141
16'	860	161

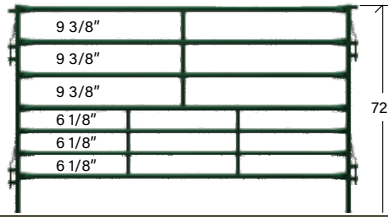

6' High Heavy Duty Panel - 7 Bar		
Length	#	Weight (lbs)
4'	809*	58
6'	816	82
8'	826	103
10'	836	124
12'	846	147
14'	856	168
16'	866	192

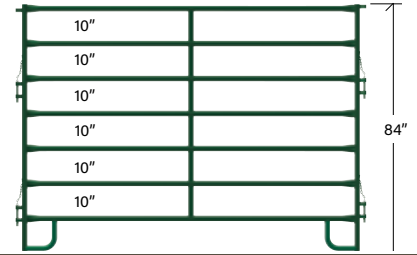

7' High Heavy Duty Panel - 7 Bar		
Length	#	Weight (lbs)
4'	2105 *	70
6'	2115 *	93
8'	2125	124
10'	2135	147
12'	2145	178
14'	2155 *	200
16'	2165	223

* Denotes a non-stock item

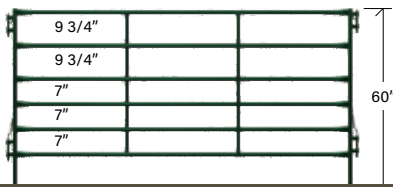

5' High Corral Panel - 6 Bar		
Length	#	Weight (lbs)
6'	750	51
8'	760	66
10'	770	78
12'	780	93
14'	790	105
16'	800	120

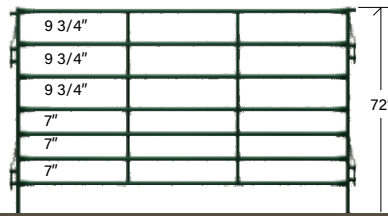

6' High Corral Panel - 7 Bar		
Length	#	Weight (lbs)
6'	756*	59
8'	766	77
10'	776	91
12'	786	109
14'	796	123
16'	806	141

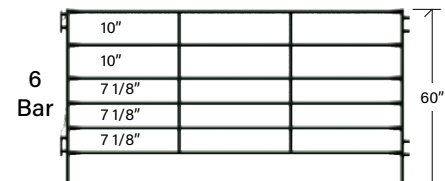
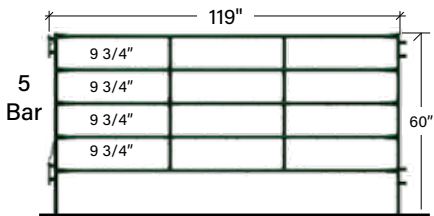

5' High Handy Panel - 5 Bar & 6 Bar		
Length	#	Weight (lbs)
10'	720	58
12'	730	70
10'	726	67
12'	736	80

Most popular

The 5 bar, 10' Handy Panel is the most popular of our panels. This light weight utility panel with included pins makes a great portable panel. Terrific for low stress perimeter fencing, creating a temporary pen, or for securing a wellhead. We maintain a large stock of these panels. (Item #720)

Livestock panel sizes

The actual length of all Hi-Hog panels is 1" less than the descriptive name. For example a panel that is described as 10' long is actually 9'-11" long, or 119" (this measurement is made from the outside edge of the panel connectors).

What's in stock?

Hi-Hog maintains a large inventory of stock items. Please note however, some low demand items are built in small quantities and may not be in stock at time of order. These items are regarded as Special Order items. Special Order items are identified with an asterisk following the item number.

WALL CONNECTORS



Horizontal



Vertical

These connectors bolt to a post or wall and connect with a pin to the panel.

2"x 5" plate x 2-1/2" deep

Style	#	Weight (lbs)
Horiz.	1111	0.8
Vertical	1110	0.8

CONNECTORS:

LINKS

Connect multiple panels at one connection. Use two links for each panel connection.



#1112 - 0.5 lbs
1-1/2" x 4" x 1/4"

4' PINS

When you have two items that need to be connected, insert the connector pin through both the top and bottom connector to create a secure link.

#1313 - 3.0 lbs
3/4" OD x 48"

2-7/8" O.D. STEEL POSTS

*Non-stock, special order

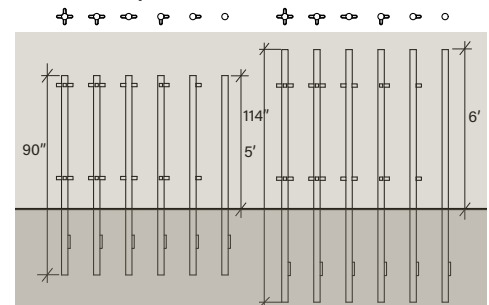

PANELS WITH GATES - SHEETED BISON PANELS



7' High Heavy Duty Panel - Sheeted

Length	#	Weight (lbs)
4'	2100 *	143
6'	2110 *	216
8'	2120	277
10'	2130	350
12'	2140	441
14'	2150	519
16'	2160	585

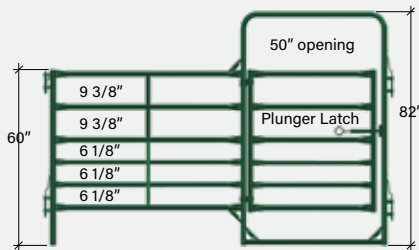

5'h Heavy Duty Panel - 6 Bar w Gate

Length	#	Weight (lbs)
-	-	-
6'	811 *	118
8'	821	135
10'	831	155
12'	841	173
14'	851*	190
16'	861*	210

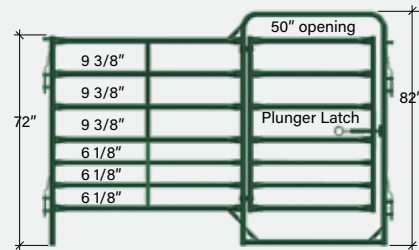

6'h Heavy Duty Panel - 7 Bar w Gate

Length	#	Weight (lbs)
4'	-	-
6'	817 *	131
8'	827	151
10'	837	175
12'	847	196
14'	857 *	217
16'	867 *	241

CONNECTOR POSTS

Connector posts are used at the junction of multiple panels as an option to the connector link.

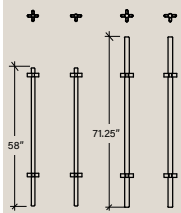

Style	O.D.	Height	#	Lbs
4 way	1.5"	58"	1100	7
3 way	1.5"	58"	1090	7
4 way	1.9"	71.25"	1101	11
3 way	1.9"	71.25"	1091	11

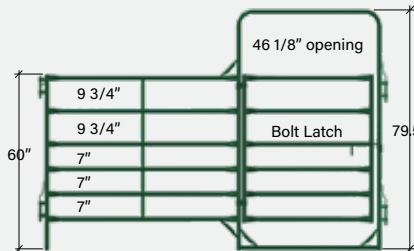

5' High Corral Panel - 6 Bar with Gate

Length	#	Weight (lbs)
6'	751 *	80
8'	761 *	92
10'	771	108
12'	781	119
14'	791 *	135
16'	801 *	150

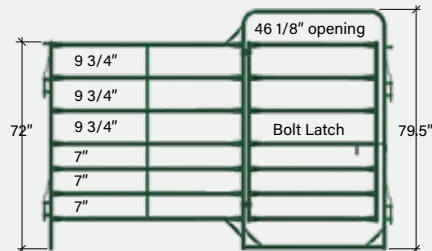

6' High Corral Panel - 7 Bar with Gate

Length	#	Weight (lbs)
6'	757 *	89
8'	767 *	103
10'	777	121
12'	787	134
14'	797 *	152
16'	807 *	170

7' CONNECTOR POSTS

84" Connector posts are used at the junction of multiple panels in Bison System as an option to the connector link. The Connectors line up with all Hi-Hog Alley Components.

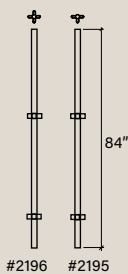

Style	O.D.	Height	#	Lbs
4 way	1.9"	84"	2196	14.5
3 way	1.9"	84"	2195	14

4-1/2" O.D. STEEL POSTS

*Non-stock, special order Fits 6-Rail Heavy Duty Gates only

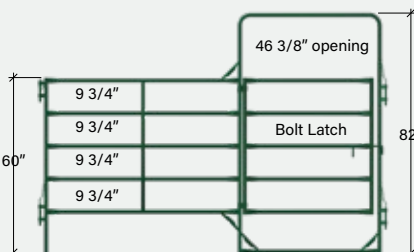
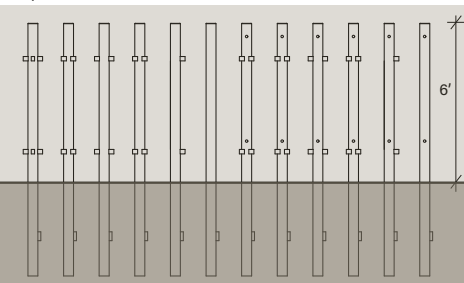
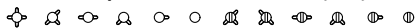

5' High Handy Panel - 5 Bar with Gate

Length	#	Weight (lbs)
10'	710	91

Built for durability

When a standard tubing panel is hit, it will bend and remain deformed. When a high tensile steel panel is hit, it will bend and then return to its original shape. The higher the tensile strength the more likely the panel will retain its original shape. Hi-Hog uses 60,000 psi high tensile tubing or better. Feel free to compare Hi-Hog's tensile strength with other brands.

Common Panel Connector Height

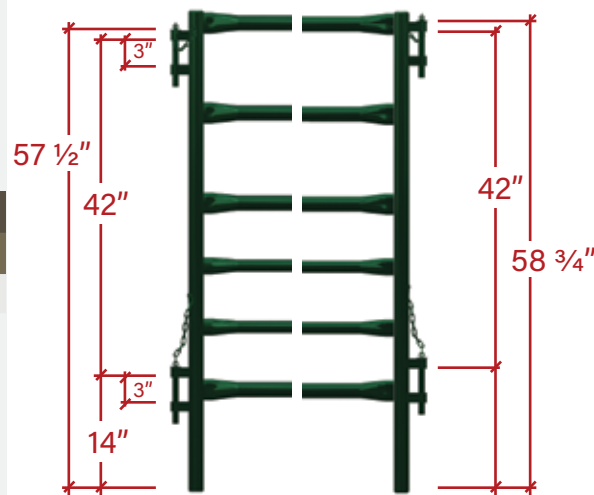

From Handy Panels to Bison Panels, Hi-Hog's common connector layout gives you versatility.

GATES / GATE LATCHING OPTIONS

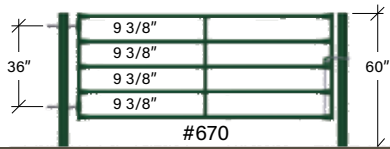

48" High Heavy Duty Gate - 5 Bar		
Length	#	Weight (lbs)
4'	640	54
6'	650	70
8'	660	89
10'	670	105
12'	680	125
14'	690	141
16'	700	157
18'	7218	176
20'	7220	193



59.25" High Heavy Duty Gate - 6 Bar		
Length	#	Weight (lbs)
4'	645	62
6'	655	82
8'	665	105
10'	675	124
12'	685	148
14'	695	167
16'	705	187
18'	7318*	210
20'	7320*	229

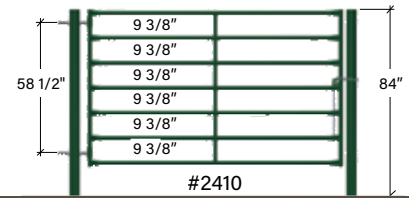

70.5" High Heavy Duty Gate - 7 Bar		
Length	#	Weight (lbs)
4'	2404*	70
6'	2406*	93
8'	2408*	120
10'	2410*	143
12'	2412*	170
14'	2414*	192
16'	2416*	215

* Denotes a non-stock item

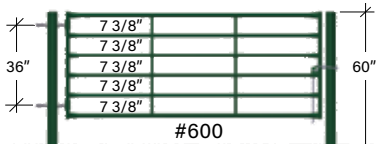

48" High Corral Gate - 6 Bar		
Length	#	Weight (lbs)
4'	570	51
6'	580	68
8'	590	86
10'	600	100
12'	610	118
14'	620	132
16'	630	149
18'	7118	164
20'	7120	181

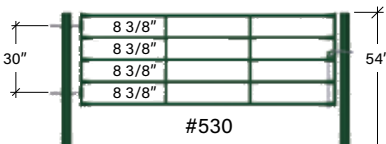

42" High Handy Gate - 5 Bar		
Length	#	Weight (lbs)
4'	500	33
6'	510	45
8'	520	58
10'	530	68
12'	540	80
14'	550	90
16'	560	110
18'	7018	123
20'	7020	136

Item Numbers and Availability of Gate Latch Options *(note: shaded items below are special order)*

	Gate Length	Standard Chain	Medium Plunger	Heavy Duty Plunger	Horse Back Lever	Horse Back Lever
					Medium	Heavy Duty
Handy 42" high	4'	500	5001	-	5003	-
	6'	510	5101	-	5103	-
	8'	520	5201	-	5203	-
	10'	530	5301	-	5303	-
	12'	540	5401	-	5403	-
	14'	550	5501	-	5503	-
	16'	560	5601	-	5603	-
	18'	7018	-	-	-	-
Corral 48" high	4'	570	5701	5702	5703	5704
	6'	580	5801	5802	5803	5804
	8'	590	5901	5902	5903	5904
	10'	600	6001	6002	6003	6004
	12'	610	6101	6102	6103	6104
	14'	620	6201	6202	6203	6204
	16'	630	6301	6302	6303	6304
	18'	7118	-	-	-	-
Heavy Duty 48" high	4'	640	6401	6402	6403	6404
	6'	650	6501	6502	6503	6504
	8'	660	6601	6602	6603	6604
	10'	670	6701	6702	6703	6704
	12'	680	6801	6802	6803	6804
	14'	690	6901	6902	6903	6904
	16'	700	7001	7002	7003	7004
	18'	7218	-	-	-	-
Heavy Duty 59.25" high	4'	645	6451	6452	6453	6454
	6'	655	6551	6552	6553	6554
	8'	665	6651	6652	6653	6654
	10'	675	6751	6752	6753	6754
	12'	685	6851	6852	6853	6854
	14'	695	6951	6952	6953	6954
	16'	705	7051	7052	7053	7054
	18'	7318	-	-	-	-
20'	7320	-	-	-	-	

GATE DIMENSIONS

The Handy Gate length is 9'-7". The Corral and Heavy Duty Gate length is 9'-6.75"
The gate length is measured from the outside edges of the gate verticals (not including hinge collars).

A 10' gate is designed to fit a 10' opening. The center of the top hinge is approximately 6" below the top of the gate vertical (with the gate mounted approximately 12" above grade).

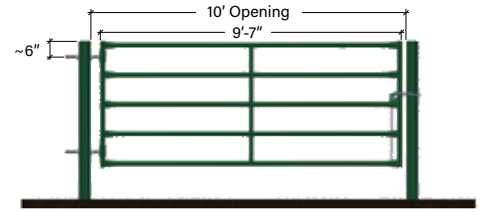

ROAD CONTROL GATES 2 - #8812 = 24' Inside Span



Add a layer of security to prevent break-ins and vandalism

- Special Order Park Access Gates 24' Inside double gate width.
- Common 2 lane entrances can be spanned by a single gate, but for wider entrances double swing gates give added stability.
- Manual swing-open barrier gates are made of heavy duty welded steel construction. They are typically powder coated in gloss black or Hi-Hog green with florescent hazard tape.

* Road Control Gates are a Special Order Item, please contact Hi-Hog for quotes and design assistance.

STANDARD CHAIN LATCH

Unless specified by the customer, all Hi-Hog gates come complete with 48" of 1/4" chain as well as a simple chain latch.

To latch, slide the chain into the locking slot and then pull the chain through the hole in the latch.



PLUNGER LATCHES

The Heavy Duty 7/8" plunger latch works in most situations. The Stockyard 1 1/8" latch is mainly used in extreme pressure situations.

Heavy Duty >



Stockyard >



Model	Bolt Size	#	Weight (lbs)
Heavy Duty	7/8"	1331	3.1
Stockyard	1-1/8"	1330	5.7

HORSE-BACK LEVER LATCHES

Simply lift the handle and push towards the spring loaded plunger latch to release (Plunger Latch sold separately). To close the gate just push the gate shut and it will lock automatically. Each gate model requires a specific lever latch (refer to the selection chart below). If ordering a gate with latch installed, see the table on page 42 for the item number.

HORSE-BACK DROP LATCHES

The drop latch is designed to be operated from horse back. A 4" rod slides through tubing that is attached to the end of the gate at a 45 degree angle. This latch uses gravity and requires the operator to lift the latch for both opening and closing.



Fits this Gate	#	Weight (lbs)
Handy	1321	5.4
Corral	1322	6.6
Heavy Duty 4' high	1323	5.8
Heavy Duty 5' high	1324	7.7
Round Pen	1325 *	5.9

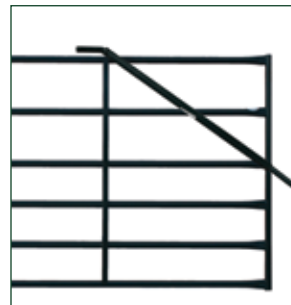

HORSE BACK DROP LATCH			
Model	Bolt Size	#	Wt (lbs)
Medium	7/8"	1334	8.9
Heavy	1-1/8"	1333	18.5

WELD-ON STRIKER PLATE

Dimensions: 4"w x 4"h x 2"d
Plate is 3/16" thick, Made to fit a 2-7/8" Dia. Post



Model	For Bolt Size	Slot Width	#	Weight (lbs)
Heavy	1-1/8"	1.5"	1650	1.4

BOLT-ON STRIKER PLATE

Dimensions: 7-3/8"w x 4"h x 1-3/8"d
Plate is 3/16" thick, 7/16" diameter bolt holes



Model	For Bolt Size	Slot Width	#	Weight (lbs)
Heavy	1-1/8"	1.5"	1651	1.3

U-FRAMES WITH GATES

An excellent alternative to the traditional overhead bow gate, for those who do a lot of tractor work, or for providing access for oversized vehicles.

U-Frames offer a wider range of options over traditional bow gates. The U-Frame allows for alley widths up to 18' and gate widths up to 16'.

The U-Frames are available in both 5' and 6' heights.

The heavy duty U-frame is built for strength and durability. The strength of the U-frame is secured in the 4.5" OD foundation tube.

The 13" steel trussed hinge post provides superior strength to support the gate without deflection.

The 13" trussed offset creates a safe zone where a handler can safely escape.

The hinge post comes with sleeves designed to fit any of our standard corral or heavy duty gates with adjustable hinges.

Because the gate is a separate option, it can be easily removed and/or replaced.

Gates can be purchased with a chain latch or a 7/8" plunger latch. The included striker plate is set at a height for use with Hi-Hog's heavy duty gates. If you wish to use a corral gate with a 7/8" plunger latch, you will need to purchase and mount an additional weld-on striker plate; #1648 (call for instructions).

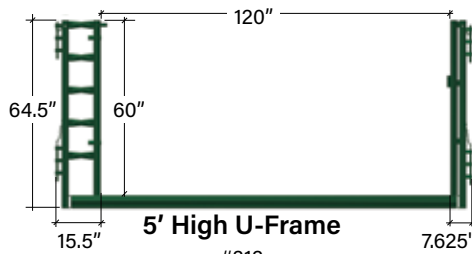

5' High U-Frame

#312

60" High U-Frame		
Length	#	Weight (lbs)
8'	308 *	172
10'	310	194
12'	312	215
14'	314	237
16'	316	259
18'	318	280

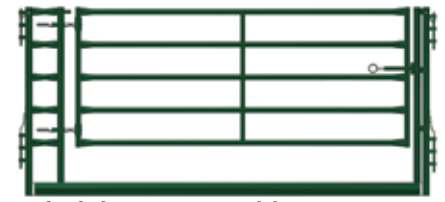

5' High U-Frame with HD Gate

#312 + #6701

60"h U-Frame		HD Gate w Plunger Latch	
Length	#	5' high	
8'	308 *	6'L - #6501	
10'	310	8'L - #6601	
12'	312	10'L - #6701	
14'	314	12'L - #6801	
16'	316*	14'L - #6901	
18'	318*	16'L - #7001	

U-Frame Extension Set

#	Height	Weight (lbs)
305 *	12"	27



Item #305

The optional item #305 can be added to an existing U-frame to add 12" to the height.

Note: The U-Frame will connect with any Hi-Hog panel. Be aware that the bottom 4.5" O.D. rail is intended to be buried below grade. If you are installing on top of a finished surface such as concrete, this rail may present a hazard.



6' High U-Frame

#312-6

72" High U-Frame		
Length	#	Weight (lbs)
8'	308-6 *	188
10'	310-6	209
12'	312-6	231
14'	314-6	253
16'	316-6	274
18'	318-6	296

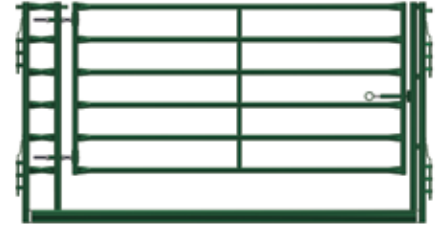

6' High U-Frame & Gate combo

#312-6 + #6751

72"h U-Frame		HD Gate Pairing	
Length	#	6' high	
8'	308-6 *	6'L - Gate #6551	
10'	310-6	8'L - Gate #6651	
12'	312-6	10'L - Gate #6751	
14'	314-6	12'L - Gate #6851	
16'	316-6	14'L - Gate #6951	
18'	318-6	16'L - Gate #7051	

U-SPREADERS

Like the U-Frame, U-Spreaders allow you to fix the width of an alley without using posts in the ground or an overhead spreader.

- The posts are built with heavy 2-3/8" OD (.154 wall) tubing and are open top and bottom.
- The Ground Rail is 2 7/8" OD (.203 wall) tubing.
- The posts are welded to a U-Bracket, which is also a cap for the ground rail and reinforced with 6" gussets.



6' High U-Spreader

#1745

72" High U-Spreader		
Length	#	Weight (lbs)
4'	1741 *	74
6'	1742 *	86
8'	1743	97
10'	1744	109
12'	1745	120
14'	1746 *	132

FRAMES WITH GATES

Frames with gates as well as overhead alley spreaders provide a versatile corral option. The common connector system allows you to use any of these items with any Hi-Hog panel. If you need the gate somewhere else, simply un-pin it and move it to the new location. The #382 - Calf Sorting Gate (p. 37) and #1160 - Calving Enclosure Frame & Gate (p. 35) provide additional Frame & Gate sorting and low roof options. The actual length of a frame & gate is 1" less than the descriptive name. For example, a frame & gate that is described as 12' long is actually 11'-11" long from the outside edge of the panel connectors.

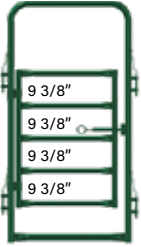

#350

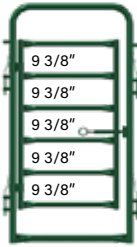

#351

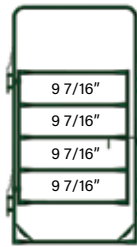

#1540

Heavy Duty Gate in 7' High Frame

L	Gate Ht	#	Wt (lbs)
4'	60"	350	109
6'	60"	352	137
4'	71-1/4"	351	117
6'	71-1/4"	355	155

Handy Gate in 7' High Frame

L	Gate Ht	#	Wt (lbs)
4'	60"	1540	46

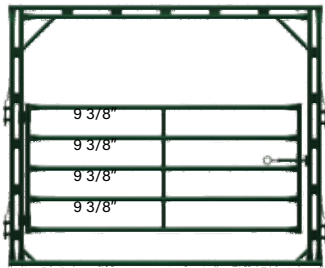

#370

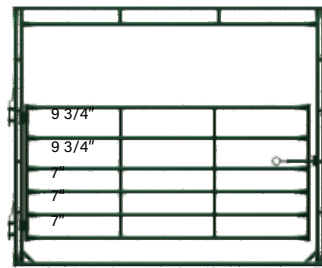

#375

Heavy Duty Gate in 8' High Frame

L	Gate Ht	#	Wt (lbs)
8'	60"	360	185
10'	60"	370	214
12'	60"	380	246

Corral Gate in 8' High Frame

L	Gate Ht	#	Wt (lbs)
8'	60"	365	143
10'	60"	375	164
12'	60"	385	189

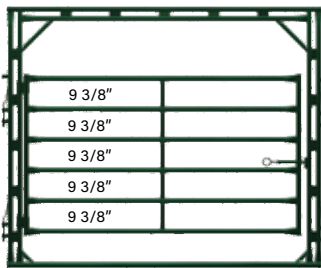

#371

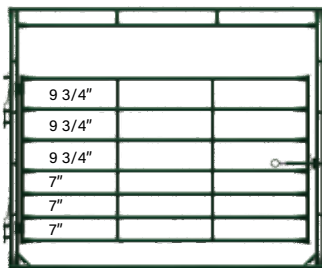

#376

Heavy Duty Gate in 8' High Frame

L	Gate Ht	#	Wt (lbs)
8'	71-1/4"	361	199
10'	71-1/4"	371	231
12'	71-1/4"	381	267

Corral Gate in 8' High Frame

L	Gate Ht	#	Wt (lbs)
8'	71-1/4"	366	153
10'	71-1/4"	376	176
12'	71-1/4"	386	204

* Denotes a Non-Stock Item

OVERHEAD SPREADERS



#1690



#1700

Alley Spreader - 1 Piece Frame

L	Frame Ht	#	Wt (lbs)
4'	7'	1660 *	74
8'	8'	1670 *	104
8'	10'	1680 *	116
10'	8'	1690	116
12'	8'	1720 *	128

Alley Spreader - 4 Piece Frame

L	Frame Ht	#	Wt (lbs)
10'	10'	1700 *	147
10'	12'	1710 *	159
12'	10'	1730 *	159
12'	12'	1740 *	171

The actual length of an overhead alley spreader is 9 1/4" longer than the descriptive name. For example, a 12' long overhead alley spreader is actually 12'-9 1/4" long from the outside edge of the spreader connectors. The end posts come with three-way connections.

Note: 10' and 12' high overhead frames with gates are available by special order. If you require more than 8' of overhead clearance we recommend Hi-Hog's U-Frames with gates as they offer unmatched clearance and more versatility. The one exception is if you intend to install your frames with gates on a solid surface. In this situation the base rail of the overhead frame is a smaller diameter compared to the 4.5" diameter U-frame bottom rail.

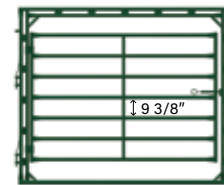

#2610



#2510

8' Frame with 84" high Gate - 7 Bar

Length	#	Weight (lbs)
8' x 8'	2608 *	255
10' x 8'	2610 *	297
12' x 8'	2612 *	344

8' Frame with 84" high Gate - Sheeted

Length	#	Weight (lbs)
8' x 8'	2508 *	399
10' x 8'	2510	477
12' x 8'	2512	567

CATTLE GUARDS

Stronger Cattle Guards mean a Safer more secure Ranch and Wellsite. – From ranch to oilfields, Hi-Hog's Texas Gates provide the security and durability you need.



3818XR - 18' Single Sill Texas Gate with optional Gate Posts, Handy Gates and Smooth Ride Bars.

Sill Options

- If you're placing your cattle guard on concrete sills, (or other structural support) select cattle guards with no sills
- If you're digging a trench and installing your cattle guard on stable ground, select a cattle guard with single sills.



2026 - Cattle Guards

Road Width	No. of Sills	#	Axle Load Rating	Weight
10'	Single	3810XR*	7,393 kg	1634 lbs
10'	None	3610X*	7,393 kg	1634 lbs
14'	Single	3814XR*	6,934 kg	2212 lbs
14'	None	3614X*	6,934 kg	2212 lbs
18'	Single	3818XR*	6,832 kg	2789 lbs
18'	None	3618X*	6,832 kg	2789 lbs

Hi-Hog's cattle guards are available in three widths; 10', 14' and 18'.

If you require a wider cattle guard, you can combine cattle guards. When combining cattle guards you will require a connector set #3529X*

Cattle Guard Options

Description	#	Weight
Set of Smooth Ride Bars	3825X*	347 lbs.
Cattle Guard Connector Set	3529X*	12 lbs.
Handy Gate post for 42" h Gate	3526X*	34 lbs.

10'-14'-18' Lengths With Smooth Ride Bars Increase the Load Capacity

Smooth Ride Bars are 5/8" x 2" Flat bar. Smooth Ride Bars will increase all Texas Gate load ratings to an axle capacity of 90KN, or 9,278 kg, which is equal to a (B1) Range Type Certification.

WELL SITE PROTECTION

WELLHEAD FENCE

Protect your investment and lower your risk with Hi-Hog's heavy duty wellhead fencing.

The cattle guard fence of choice for oilfield, pipeline and utility companies. The quick connect design offers superior flexibility for set-up on uneven terrain. The top rail connector removes the risk of animal leg traps.

Quick installation
No Tools Required

Tubing is coned to ensure there are no sharp edges.

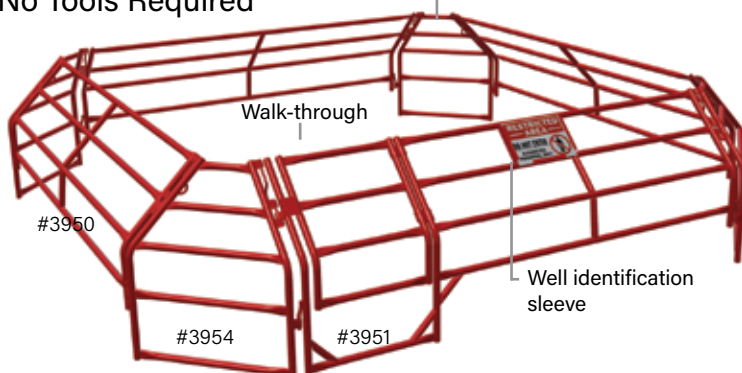

Wellhead Fence

Panel Description	#	Weight (lbs)
5' Well Fence Panel	3955	28
10' Well Fence Panel	3950	48
10' Well Fence Panel with Man Gate	3951	67
Well Fence Connector	3953	17
2' Well Fence Outside Corner Panel	3954	24
2' Well Fence Inside Corner Panel	3959*	35

Well Fence, Guy Wire Guards and Cattle Guards are built several times a year, but may not always be in stock. Please call for availability.

GUY WIRE GUARDS

For small hazards such as guy wires, these panels offer an alternative to our standard wellhead fence system. Simply pin three panels around the hazard and if necessary stake them to the ground (ground stakes included)

- High Visibility Guy-Wire Protection
- Tool Free Easy On-site Installation
- Hi-Tensile Steel Tubing Construction
- Safety Features (Coned Tubing Ends + Ground Stakes)
- Stackable, Easy Transport Design
- Powder coat paint finish in **Safety Red**
- Ships anywhere in North America

Weight: 26 lbs. per panel, 78 lbs for a set of three.

All Hi-Hog oilfield fencing panels are manufactured in our Calgary facility using hi-tensile North American steel tubing. Designed for durability, livestock control, and site security, our wellhead fencing systems are supported by a strong independent dealer network across North America.



Use the QR code to visit Hi-Hog's Wellhead page on the website, for complete Panel sizing, options and Independent Dealer Locations.



Guy Wire Cattle Guard		
Description	#	Weight (lbs)
Guy Wire Panel	3977	26

NIFTY FEED DISPENSER

Shipping Dimensions

Drum diameter: 60 9/16"

Drum width: 29 3/4"

Drum width with axle sleeves: 35 3/4"
(Shown with axle extensions attached)



The Nifty Feed Dispenser allows a single operator with a round bale handler or trailer-style feeder to load, transport, and dispense grain, cake feed, pellets, or supplements under range feeding conditions.

With a 37-bushel capacity, this versatile dispenser is ideal for winter and summer supplementation, pre-breeding conditioning, or extended pasture feeding during drought. The dispenser delivers feed at consistent 15-foot intervals, and the adjustable hopper opening gives you precise control over how much feed is dispensed with each rotation.

A baffled interior allows supplements to be mixed evenly into the feed, and the Nifty Feed Dispenser can deliver enough supplement for up to 250 head in a single trip, helping you save time and labour in large pasture operations.

Nifty Feed Dispenser	
#	Weight (lbs)
8965	738

NIFTY FEED DISPENSER TRAILER

Shipping Dimensions

Length: 123 7/16"

Width: 70 11/16"

Height: 40 3/8"

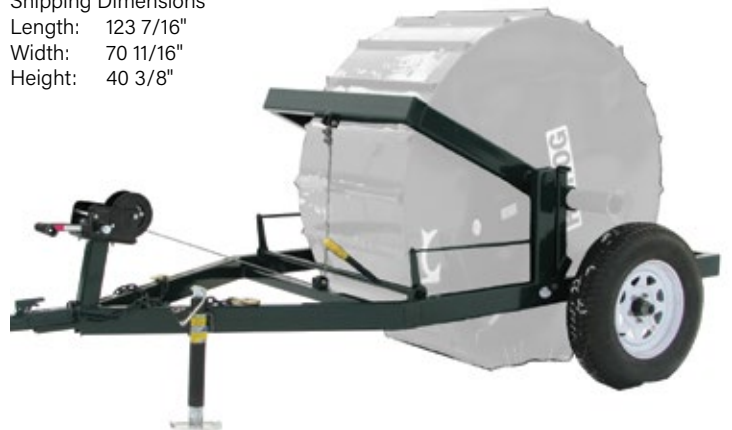

The Nifty feed dispenser trailer provides an additional method for transporting and dispensing feed with your Nifty feed dispenser. This heavy duty trailer has been designed to make it easy to load, transport and feed with your Nifty feed dispenser.

- Maximum gross weight of a loaded Feed Dispenser Trailer is 4,000 lbs. This is based on the load limit of the tires we are using.
- The combined trailer and dispenser weight is 1,237 Lbs

Includes:

- New 15" tires
- 2" lockable ball hitch
- Heavy cross tie chains
- 2000 lb winch with auto lock
- 2000 lb trailer jack
- Dispenser sold separately

Nifty Feed Dispenser Trailer	
#	Weight (lbs)
8966	476

SLANTBAR FEEDER PANEL



A double top rail provides additional strength. Tubing ends have been coned to eliminate sharp edges. Panels are 60" high.

Construction*: 1-1/2" OD, 14 ga. for the top rail. 1.9" OD, 12 ga for the two interior horizontals and 1.9 OD 14 ga. for the bottom horizontal and outside verticals. The slant bar stanchions are 1-5/16" OD, 0.125 wall.

*The 16' slant bar panel is built heavier.

TOMBSTONE FEEDER PANEL

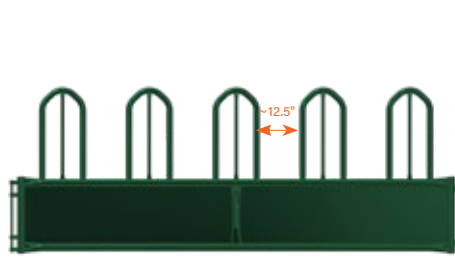

The Tombstone Feeder Panel provides improved access for horned animals such as cattle or bison, and is preferred for feeding horses because there is no top horizontal bar for the horses to wear their manes on.

Construction: 2-3/8" OD, for the panel frame. 1.9" OD, 14 ga, for the tombstone hoops, and 1" OD, 14 ga. for the interior vertical inside the tombstone hoops. Panels are 49" high.

CREEP FEEDER PANEL

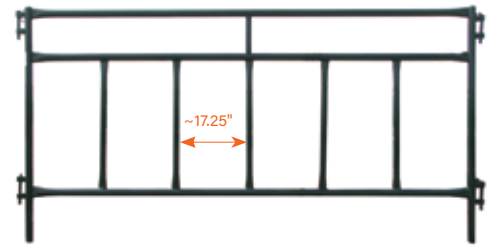

The 60" high Creep Panel is used to help separate calves from their mothers. The stanchions are wide enough (17.25" opening) for calves to step through to access feed, while the cows are restricted to one side. Tubing ends have been coned to eliminate sharp edges.

Construction: Built from 1-1/2" OD, 16 ga. & 1.9 14 Ga hi-tensile steel tubing.

Slant bar Feeder Panels			
Length	Feed Pos.	#	Weight
8'	5	980 *	139 lbs
10'	6	990	168 lbs
12'	8	1000	199 lbs
16'	10	1010 *	294 lbs

Tombstone Feeder Panels			
Length	Feed Pos.	#	Weight
7'-1"	2	1050	112 lbs
9'-6"	3	1060	151 lbs
11'-7"	4	1070	183 lbs
16'	6	1080 *	272 lbs

Creep Feeder Panels			
Length	Feed Pos.	#	Weight
9'-11"	6	1490	81 lbs

* Denotes a non-stock item

HURRICANE MULTI-BALE FEEDER



The Hurricane Multi-Bale Feeder is a rugged two bale feeder. To assemble this feeder simply combine two 8'-5" straight Hurricane Feeder Panels with two 14'-8" straight Hurricane Feeder Panels. The panels pin together to create a rigid corner brace. Panels are 60" high. Stanchion width is 13.5"

The stanchions project in towards the bale to keep feed inside the feeder. This feeder has 30 feeding positions. This feeder can be extended by using an 8' U-frame as a spreader (#1743). These panels can also be used as fence line feeder panels.

Hurricane Multi-Bale Feeder			
#	Quantity	Length	Item Weight (lbs)
1245	2	8'-5"	157
1246	2	14'-8"	269

HURRICANE SQUARE BALE FEEDER



The Hurricane Square Bale Feeder has an inside dimension of 8'-11" x 5'-2". To assemble this feeder simply combine two 7'-2" straight Hurricane Feeder Panels (#1244) with two 10'-11" straight Hurricane Feeder Panels (#1248). The panels pin together to create a rigid corner brace. Panels are 60" high. Stanchion width is 13.5"

The stanchions project in towards the bale to keep feed inside the feeder. This feeder has 22 feeding positions. These panels can also be used as fence line feeder panels.

Hurricane Square-Bale Feeder			
#	Quantity	Length	Item Weight (lbs)
1244	2	7'-2"	136
1248	2	10'-11"	202

TWISTER ROUND BALE FEEDER



Cow/Calf Feeder

Construction: The frames are 1" square tubing 0.100 wall. The stanchions are 1-5/16", 0.125 wall. The bale saver stanchions project inwards to reduce feed waste. The stanchions are slanted diagonally to deter livestock from climbing into the feeder. The 20.75" high base is sheeted on the outside with 16 gauge sheet metal. Three sections bolt together to create a solid cow/calf feeder.

The Twister Round Bale Feeder provides the best value for your dollar.

18 Feeding Positions

85" ID, 101" OD

Twister Round Bale Feeder	
#	Weight (lbs)
961	327

HURRICANE ROUND BALE FEEDER



Cow/Calf Feeder

Construction: The frames are 1.9" OD 14 gauge. The stanchions are 1-1/2", 14 ga. The bale saver stanchions project inwards to reduce feed waste. The 22" high base is sheeted on the outside with 16 gauge sheet metal. Three sections pin together to create a solid cow/calf feeder.

Hi-Hog's Heavy Duty Cow / Calf feeding option.

18 Feeding Positions

88.5" ID, 108" OD

Hurricane Round Bale Feeder	
#	Weight (lbs)
913	354

TORNADO ROUND BALE FEEDER



Bull Feeder

Construction: The frames and stanchions are 1.9" OD, 14 gauge. The bale saver stanchions project inwards to reduce feed waste. The 22" high base is sheeted on the outside with 16 gauge sheet metal. Three sections pin together to create a solid bull feeder.

15 Feeding Positions

89" ID, 108" OD

Tornado Round Bale Feeder	
#	Weight (lbs)
923	357

TOMBSTONE ROUND BALE FEEDER



Cow / Calf / Bison / Horse Feeder

Construction: 1.9" OD high tensile, 12 gauge tubing for the frame, and 1.9" OD, 14 gauge for the hoops. Each of the hoops is filled with 1"OD 14 gauge interior vertical. Each corner and tombstone hoop is also braced. The 22" high base is sheeted on the outside with 16 gauge sheet metal. Three sections pin together to create a solid, versatile Stock feeder. This feeder is preferred by ranchers with horned livestock. There is no top horizontal hoop for horses to wear their manes on.

12 Feeding Positions

95" ID, 113" OD

Tombstone Round Bale Feeder	
#	Weight (lbs)
954	390

STANDARD BOX STALL FRONT

Over forty years of design improvements have resulted in the refined and polished Standard Box Stall of today; a simple design perfectly executed.

The quality and condition of your stabling environment affects the health and performance of your horse. Surround your horse with The Standard your horse desires and deserves.

Note: The stall front shown is a Right Hand Stall Front because the door is located on the right side when you look at the front of the stalls. For assistance laying out your stables call us and we can prepare a scaled plan for you. **Lumber not included**



Item #1630

*Add 24" for 12' fronts

Standard Stall Front - Comes with Feed Gate				
Length	Height	Door	#	Weight (lbs)
10'	7'-4"	Right	1630	229
10'	7'-4"	Left*	1631	229
12'	7'-4"	Right	1640	255
12'	7'-4"	Left*	1641	255

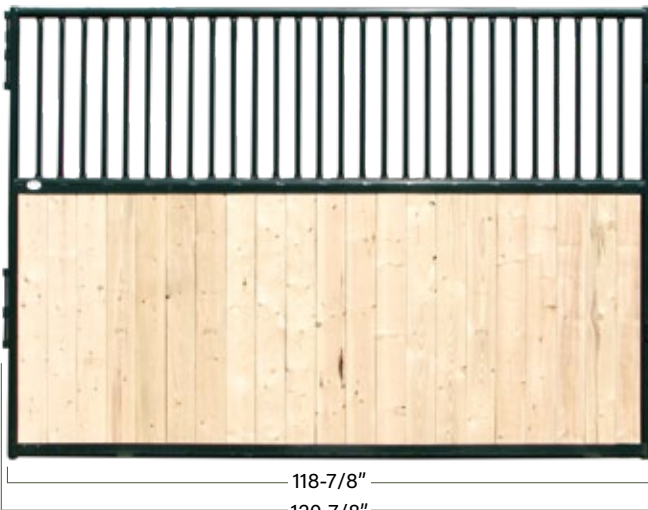

Item #4210

*Add 24" for 12' open top partitions

OPEN-TOP PARTITION

Open-Top Partitions are available in 10' and 12' lengths. The heavy duty 1.9" OD, 14 gauge steel frame provides safety and security. The vertical bars are set on 4" centers (3" opening). To finish assembly simply slide the lumber of your choice into the integrated channels and bolt the last piece in place.

The Open Top Partition will bring more light and better ventilation into the stall. Open top partitions are recommended for end stalls or where the neighboring horses are comfortable with each other. **Lumber not included**

Open Top Partition			
Length	Height	#	Weight (lbs)
10'	7'	4210	154
12'	7'	4212	181



Item #4110

*Add 24" for 12' All Plank partitions

ALL-PLANK PARTITION

All-Plank Partitions are available in 10' and 12' lengths. The heavy duty 1.9" OD, 14 gauge welded steel frame provides the safety and security that you demand.

Designed for quick installation. The partitions pin directly to the stall fronts. Channels are built into the frame to receive your lumber. Simply slide the lumber into the channel and secure the last board in place. Additional rigidity is achieved by tying each of the boards to the included strapping set (the vertical flat bar shown in the middle of the partition. The 10' partition includes one strapping set and the 12' partition includes two strapping sets. **Lumber not included**

All-Plank Partition			
Length	Height	#	Weight (lbs)
10'	7'	4110	94
12'	7'	4112	114

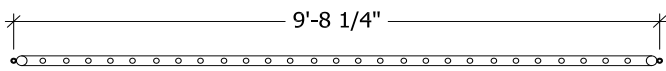

Item #4211

*Add 24" for 12' open top foaling partitions

FOALING PARTITION

Foaling Partitions are available in 10' and 12' lengths. The heavy duty 1.9" OD, 14 gauge steel frame provides strength and security.

Foaling Partitions are designed so they can be removed to create a large temporary foaling stall, without compromising the structural integrity of your stall structure.

If you want to include a Foaling Partition please be aware that you will also require a foaling tele-post (the tele-post goes in between the stall fronts) and a set of foaling stall brackets (#4062 x 2) at the back wall of the stall. *** May not always be in stock. Lumber not included**

Open Top Foaling Partition		
Description	#	Weight (lbs)
10' Foaling Partition	4211*	152
12' Foaling Partition	4213*	179
Foaling Telepost	1638*	44
Foaling Spreader	1639 *	25
Foaling Wall Bracket	4062 *	1.7

Stall Hardware		
#	Description	Weight
4060	6x4 horizontal wall bracket	1.7
4061	4x6 vertical wall bracket	1.5
4062	6x4 horizontal foaling wall bracket	1.7
4063	3x5 offset wall bracket	1.2
1635	Standard 3-way connector post	12.8
4096	Wall Mount - Partition Channel	14
4097	Front Mount - Partition Channel	14
4098	Partition Strapping Set	14
4099	Partition Channel Set	28

Connecting Hardware

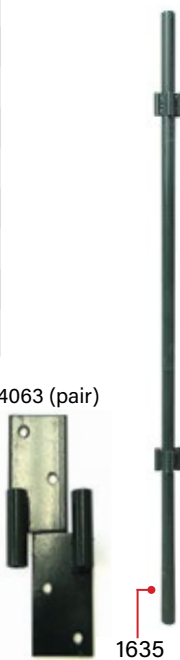

Partition Components

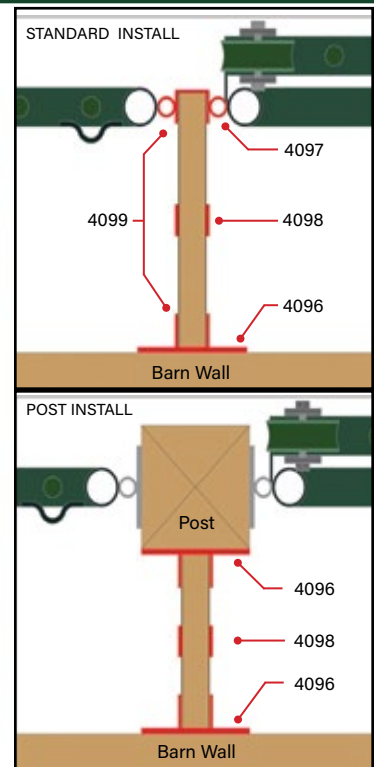

For Stand Alone Stalls, one #1635 Connector Post is required for each Bank of Stalls.

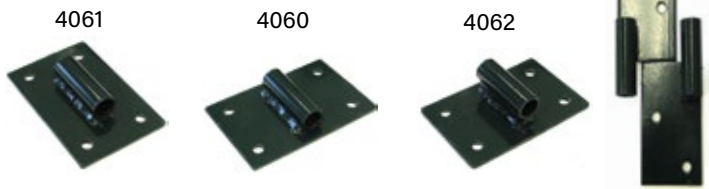

HORSE STALL OPTIONS



HAY MANGER
Wall Mount Hay Manger
Item #4030, 20 lbs



CORNER FEEDER
Corner Feeder w Support Ring
Item #4040, 14 lbs



BLANKET HANGER
Horse Head Blanket Hanger
Item #4329, 3 lbs

STANDING TIE STALLS AND TIE STALL MANGERS



Tie Stalls		
Description	#	Weight (lbs)
10' Tie-Stall Partition	6115	148
Tie Stall Feed Manger	6113	82



Standing Tie Stall Partitions, Item #6115.

The partitions are 10' long. The front section is 7' tall and the back section is 52" tall.

Attach the front of the partition to the barn wall with two wall brackets (item #4061 or #4062 - see page 51). The rear of the partition comes standard with an adjustable telepost which lags to the barn floor and ceiling. The telepost ceiling bracket can be adjusted for ceiling heights from 8' to 12'.

Loops are mounted to the rear of the standing tie stall partitions for those horses that may require a rope or chain across the rear of the tie stall.

The raised front portion of the panel comes with 16 gauge sheet metal. The bottom of the panel frame includes a channel ready to accept 16 pieces of 2x8 x 47.5" lumber.

Wood and wood fasteners are not included.

Tie Stall Feed Manger, Item #6113.

The feed mangers come with brackets for mounting at the front to a wall and sleeved brackets on the side of the manger extend to attach to the side of the tie stall partitions or the barn side wall. The manger mounts between the tie stall partitions which will be on approximately 60" centers. A tether ring is mounted on the front of the feed manger.

8 cubic foot capacity.

PORTABLE EQUINE EVENT STALLS

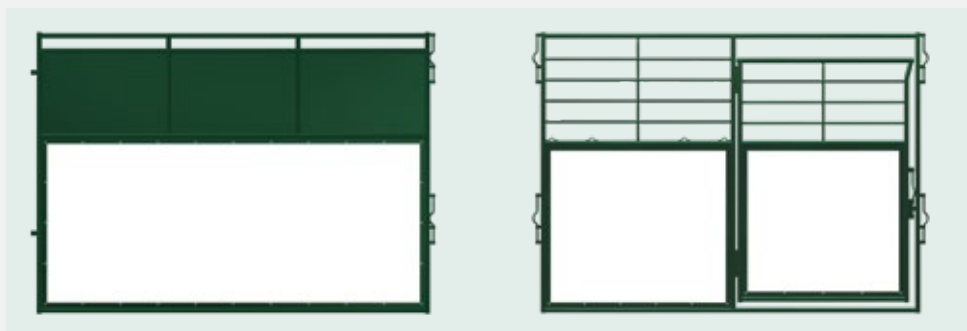

Item #4410*

PARTITION PANEL

Item #4404*

FULL HEIGHT SWING DOOR

Hi-Hog's powder-coated Portable Equine Event Stalls are engineered for fast, repeatable installation—season after season. Designed to be light enough for efficient handling yet strong enough to withstand frequent setup and takedown, these stalls deliver dependable performance for equine events of every size.

Built for professional venues and event organizers, Hi-Hog Portable Stalls are trusted by some of the most respected facilities in the industry, including Spruce Meadows, Thunderbird Equestrian, and the Calgary Stampede.

Each system is built to order and tailored to your layout requirements. Our team is available to assist with stall configuration and event-specific design.

non-stocked items - built to order

Call us at 1-800-661-7002 to begin the design process.

Event Stalls requiring roofing measure 10' x 10'. Banks of back-to-back stalls can be purchased with or without roofs.

Roof tarps are designed for stall plans with a minimum size of 20' wide by 30' long (6 stalls).

For pricing please call toll free 1-800-661-7002



Portable Stalls

Description	#	Lbs
10'w x 7'h - front	4404 *	192
10'w x 7' h - partition	4410 *	210
12'w x 7'h - front	4423 *	220
12'w x 7'h - partition	4409 *	252
3-way Connector Post	4421 *	10

PORTABLE EQUINE EVENT STALL DESIGN



Your choice of Hi-Hog's best-in-class Portable Equine Event Stalls will demonstrate your high regard for ensuring your patron's valued equine partners are safe and well cared for. Hi-Hog's outstanding event stall fronts and partitions are available in 10' and 12' lengths. **non-stocked items - built to order**

ENGINEERED FOR SAFETY AND DURABILITY

Designed with Bio-Security in Mind

Designed to support event-level biosecurity standards, with durable finishes that allow for effective cleaning between installations.

Flat-Swing Gate Design

The stall front gate is mounted on offset hinges at the center post, allowing it to open flat against the stall face for unobstructed access.

Secure, Simple Door Latch

Designed for reliable operation and ease of use during busy event conditions.

Extended Top Rail for Safety

The top rail extends toward the latch area to eliminate a potential leg trap.

Reinforced Gate Frames

Corner gussets add strength and improve long-term frame rigidity.

Additional Interior Vertical Support

Enhances structural strength and rigidity of the horizontal rails on both stall fronts and partitions.

Coned Tubing Ends

Gate tubing ends are coned to provide a smooth, rounded, and safer finish.

16-Gauge Formed Sheet Metal Panels

Partition tops are filled with formed sheet metal ridged for added strength while reducing noise and vibration.

Forklift-Ready Partition Design

A top gap in the partition allows forklifts to easily handle and reposition panels during installation and teardown.

Integrated Tie-Down Points

Stall fronts include two sets of tie-downs for securely attaching feed and water accessories.

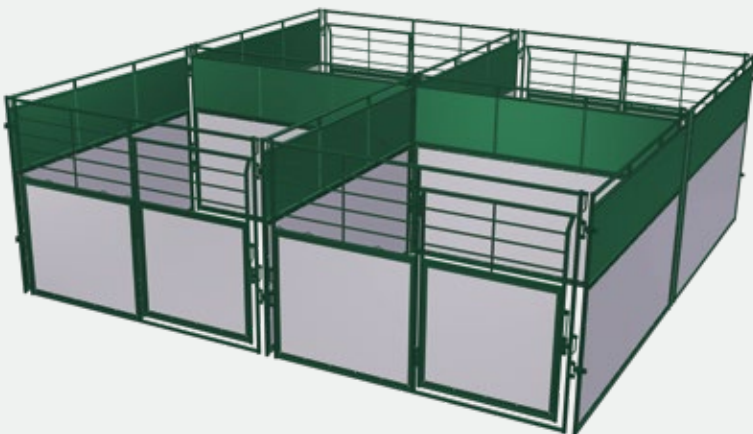

PORTABLE HORSE CORRALS

- 50" high panels
- Folded length of 6'-10"
- Unfolded length of 13'-6"
- 1.5" OD 60,000psi high tensile steel construction
- Powder coat paint finish
- Tool free, one handed latching
- Sets up quickly, easily & securely
- 3 legs per panel for stable, one person set-up
- Extended shephard latch securely locks two panels together
- Optional 4-way posts allow for multiple pens



Hi-Hog's Portable Horse Corrals are designed for riders, trainers, and competitors who need safe, dependable containment wherever they travel. Whether at horse shows, clinics, trail rides or overnight stops, these folding steel panels provide quick setup, secure connections and compact transport.

Description	#	Weight
Folding Corral Panel	746	57 Lbs
4-way Connector Post	742	10.5 Lbs

ROUND PENS



Savanna Round Pen		
Description	#	Wt (lbs)
8'-6" w x 6' h panel	2912	89
8'-6" frame w 6' gate	2913	178



Parkland Round Pen		
Description	#	Wt (lbs)
10' w x 6' h panel	2910	80
6' x 9'-3" frame w 6' h gate	2906	101

Hi-Hog's Savanna Round Pen is a foundational tool for safe, effective equine training. Ideal for groundwork, lunging, colt starting, and riding schools, the pen's tapered panel design helps discourage horses from crowding handlers along the perimeter—reducing pressure points and improving safety.

Each tapered panel measures approximately 8'-6" in length and stands 6' high, providing secure containment while maintaining excellent visibility. The gate frame matches panel length, allowing you to reposition or add a gate easily by swapping panel sections. The Savanna Round Pen is available in a range of diameters to suit private barns, training facilities, and commercial equine operations.

Standard finish: Hi-Hog Green powder coat

Lumber not included.

The perfect balance of portability and strength.

Constructed with 60,000 psi high tensile 1.5" steel tubing for superior strength (Gate tubing is 1.5" OD, 16 ga. except for the gate frame which is 1.9" OD, 14 ga.).

The panel design ensures there are no sharp edges by eliminating the use of flat bar and coning the ends on all end-cut tubing. Top connectors eliminate the leg trap gap between panels. Mud legs provide additional support and resistance against sinking in soft conditions.

The Parkland Round Pen can have a wide range of diameters. The most popular diameters are shown below.

Savanna Round Pen		
Outer Diameter	# Panels	# Gates
41' - 3"	14	1
49' - 4"	17	1
60' - 3"	21	1
70' - 11"	25	1



Use the QR code to visit Hi-Hog's Round Pen page on the website, for complete Round Pen sizing and panel amounts.

Parkland Round Pen		
Outer Diameter	# Panels	# Gates
39' - 10"	12	1
49' - 3"	15	1
58' - 7"	18	1
67' - 11"	21	1

BUCKING CHUTES



Optional Bucking Chute Crash Pad,
#1759



Use the QR code to go to Hi-Hog's Rodeo Arena Design Service website page.

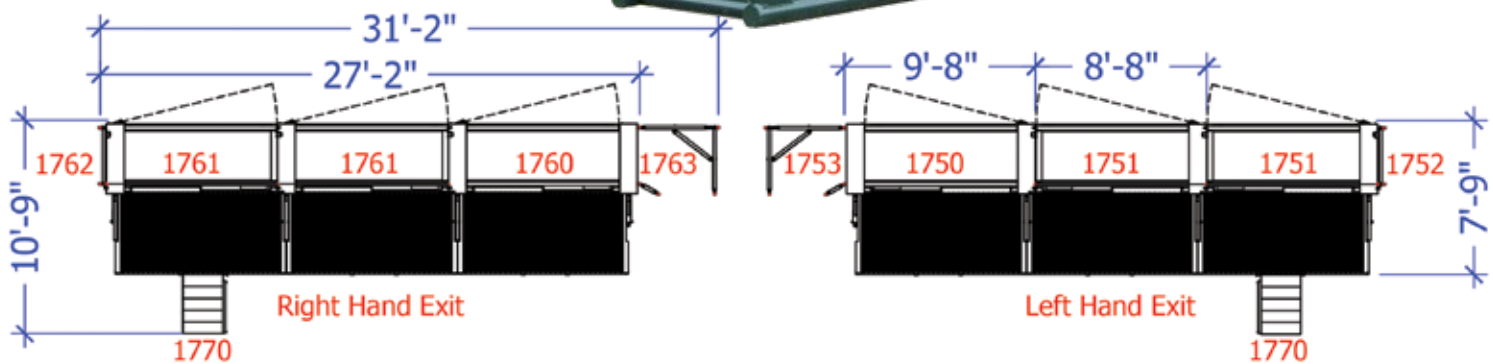

Hi-Hog's modular Bucking Chutes are engineered for agricultural societies that demand professional grade performance, enhanced safety and durability. These strong, responsive chutes deliver reliable operation for contractors while protecting riders, livestock and spectators.

Rough Stock Chute features include:

- Solid spring loaded lever latches.
- Guides lined with Tivar to reduce friction.
- Offset hinges allowing the gates to swing back flat.
- Rubber padded rolling doors that travel on a shortened upper track.

Modular Bucking Chute Components

Description	Exit	#	Weight (lbs)
Lead Bucking Chute	Left	1750 *	2,206
Add-On Bucking Chute	Left	1751 *	1,670
End connecting frame	Left	1752 *	39
Bucking Chute Corner Entry	Left	1753 *	287
Lead Bucking Chute	Right	1760 *	2,206
Add-On Bucking Chute	Right	1761 *	1,670
End Connecting Frame	Right	1762 *	39
Bucking Chute - Corner Entry	Right	1763 *	287
Bucking Chute - Catwalk Stairs	-	1770 *	136
Bucking Chute Crash Pad	-	1759 *	13

RODEO - TIMED EVENT BOX



U-Frame (#326 R),
 Supports the two 16' Side Panels
 and 12'w x 5'h Heavy Duty Gates and
 Anchors the front of the Roping Chute.

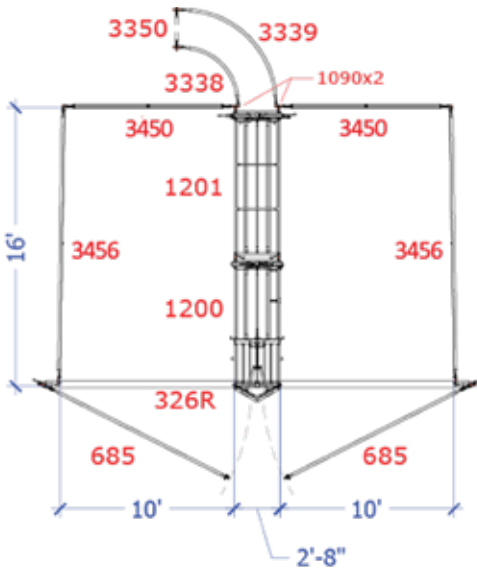

Second Stage Roping Chute
 Item #1201

First Stage Roping Chute
 Item #1200

- Built to PRCA and CPRA specifications.
- Manufactured using minimum 60,000 psi, high tensile steel tubing.
- Contoured sheeting used on the bottom 35" keeps your stock facing forward.
- Release gate springs open and locks securely.
- Equipped with quick access barrier gates on both sides of the chute.
- Operator access gate allows access to stock.
- Stock flow can be easily controlled with the side-tilt tailgate.

* Denotes non-stock items.

Call us at Hi-Hog for planning, quotes and design assistance.

Timed Event Box Components		
Description	#	Weight (lbs)
First Stage Roping Chute	1200	573
Second Stage Roping Chute	1201 *	431
Roping Box - Front U Frame	326R *	409
12' x 5' Heavy Duty Gate	685	148
16' x 6' Panel - Sheeted 48" high	3456 *	364
10' x 6' Panel - Sheeted 48" high	3450 *	224
Curved Entry Panel - 38" Radius	3338 *	72
Curved Entry Panel - 64" Radius	3339 *	105
24" wide Alley Spreader	3350 *	38

RODEO - QUICK DRAW SORTING ARROW

Sorting Pens are critical to the success of timed events where competitors draw for their calf or steer. Neither the cowboys nor the audience want to wait while you struggle to cut a specific animal out of a pen.

The Quick Draw diagonal feed system makes it easy to load your stock into individual pens. Loading the correct draw is now as easy as opening the gate on the pen that holds the number you are looking for.

Each set will hold four head. By extending the sort alley or mirroring the sort alley you can increase the number of pre-sort pens in multiples of four.

The 7 rail sorting gates keep heads out of the alley. The leadup alley is 24" wide.

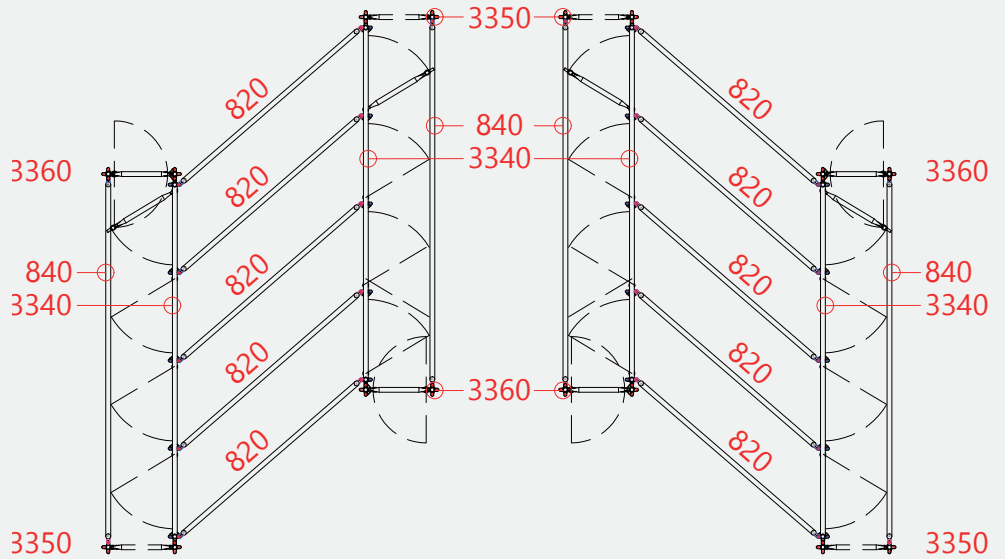

Diagonal Sorting System Components		
#	Description	Weight (lbs)
3340 *	12' Diagonal Feed Panel	257
3350 *	24" wide steer alley spreader	38
3360 *	24" wide steer alley spreader / swing gate	71
820	8' wide x 5' high Heavy Duty Panel	87
840	12' wide x 5' high Heavy Duty Panel	124

* Denotes non-stock item

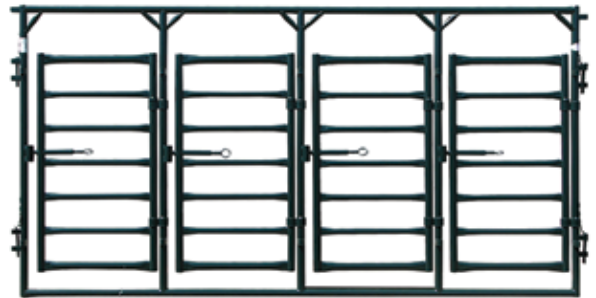

#3340 - 12' DIAGONAL FEED PANEL 143 1/4" X 72"

LET HI-HOG HELP YOU DESIGN THE BEST PLAN FOR YOUR RODEO

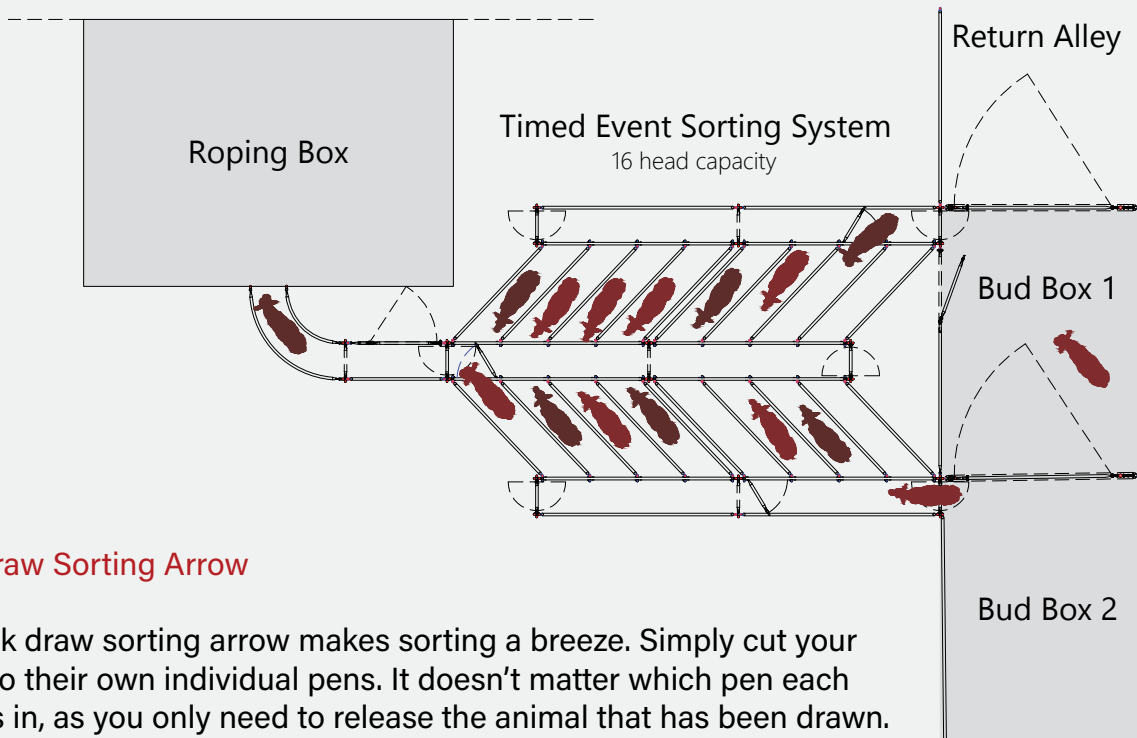

Quick Draw Sorting Arrow

The quick draw sorting arrow makes sorting a breeze. Simply cut your stock into their own individual pens. It doesn't matter which pen each animal is in, as you only need to release the animal that has been drawn.

5 AND 10 ROW BLEACHER FRAMES



5-Row Bleacher Frame Set - Stairs Right



3 sets of 10-Row Bleachers; two frames with stairs

Heavy-duty steel bleacher frames are engineered for safe, durable outdoor seating at arenas, rodeo grounds, agricultural societies, parks and recreation facilities across North America.

- Available in 5-Row and 10-Row configurations
- Each bleacher section measures 16 feet in length
- Modular design allows sections to be connected end-to-end for expanded seating capacity
- Stair access must be specified as left-hand or right-hand at time of order
- Stairs must be positioned adjacent to a handrail system
- A single 5-Row Bleacher Frame seats approximately 53 people (42 with stair configuration)*
- A single 10-Row Bleacher Frame seats approximately 106 people (82 with stair configuration)*
- Seating capacity based on 18" per person

- Optional Skid Frame Base available for installation on grass or soft surfaces and for portable applications
- Designed for installation on a level surface and proper anchoring to resist wind loads

Assembly is Required.

Package includes steel frame and steel fasteners

Wood seating planks and wood fasteners not included

*Seating capacity may vary depending on layout and local code requirements.

When your facility needs safe, dependable outdoor seating, Hi-Hog's steel bleacher frames deliver strength, compliance and long-term value. Each modular 16-foot section is built to meet ICC 300 standards and expand with your needs. Ideal for rodeo grounds, agricultural societies, parks and community arenas. Hi-Hog bleacher frames provide durable, low-maintenance seating engineered for performance in demanding environments.

PICNIC TABLE FRAMES



Hi-Hog Picnic Table Frames are built to last. Ideal for Public Parks and Campgrounds.

The angled bench support prevents the table from tipping if there are people seated on one side only.

Hi-Hog's walk through Picnic Table Frames are made from 1.5" OD 14 gauge, minimum 60,000 psi high tensile steel tubing.

Wood not included, Some assembly required

Picnic Table Frames		
Description	#	Weight (lbs)
Picnic Table Frame	8446	47

CAMPFIRE GRILL / FIRE BOX



The Fire Box includes a grill that swings safely out of the way. 1-1/2" diameter air holes are cut around the perimeter of the base to allow superior airflow. The base plate includes 1/2" diameter holes for secure anchoring.

The grill measures 18" x 18" and is made with 1/2" Round Bar. The overall footprint of the fire box is 25" x 25", and the box is 12 1/2" high.

Additional designs and options are available.

Fire Boxes		
Description	#	Weight (lbs)
Standard Fire Box	8972	61



PARK BENCH FRAMES



Relax, Hi-Hog's contoured metal Park Bench kit. The DIY Park Bench kit includes two heavy duty park bench supports (item 6160, 58 lbs.).

The bench frame is carefully formed to ensure each plank mounts flush with the steel support.

The formed base shifts the load to the outside of the base frame to provide stable footing.

*Wood not included, assembly required * Special Order*

Park Bench Frames		
Description	#	Weight (lbs)
Park Bench Frames	6160 *	58

UTV CATTLE GUARD



Hi-Hog's UTV Cattle Guard crossing makes it easy for you to move through your fence lines and into other pastures without going through a gate.

There's no need to dig a hole. Simply cut your fence, lay the cattle guard on the ground and re-attach your fencing, done!

** Special Order*

ATV Cattle Guard		
Description	#	Weight (lbs)
UTV Cattle Guard	3931 *	320



TALK TO A HI-HOG EXPERT

Toll-free in North America: 1-800-661-7002

Outside of North America: 1-403-280-8300

Fax: 1-403-280-2441

Hi-Hog's head office is located at
8447 - 23rd Avenue N.E. Calgary, AB
Our regular hours of operation are from
8:00 am to 4:30 pm Monday to Friday

CATTLE BISON EQUINE RODEO PARKS

www.hi-hog.com

www.hi-hog.com/dealer-locator

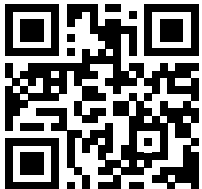

Visit our Web-Site



Find your local dealer